

Printer/Scanner Unit Type 1045

Operating Instructions Scanner Reference

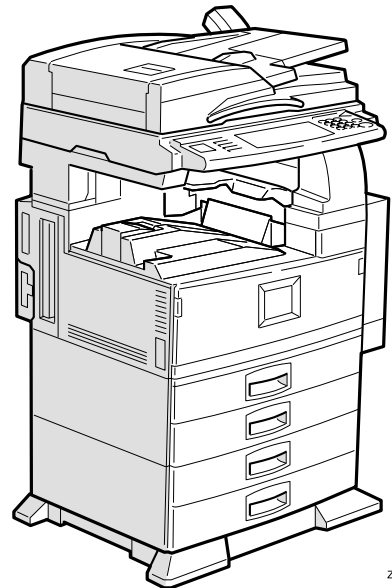

ZDPH130J

This illustration shows the product with options installed.

Read this manual carefully before you use this product and keep it handy for future reference.

For safety, please follow the instructions in this manual.

Introduction

To get maximum versatility from this machine all operators should carefully read and follow the instructions in this manual. Please keep this manual in a handy place near the machine.

Please read the Safety Information in the Copy Reference before using this machine. It contains important information related to USER SAFETY and PREVENTING EQUIPMENT PROBLEMS.

Important

Parts of this manual are subject to change without prior notice. In no event will the company be liable for direct, indirect, special, incidental, or consequential damages as a result of handling or operating the machine.

Caution:

Use of controls or adjustment or performance of procedures other than those specified in this manual might result in hazardous radiation exposure.

Trademarks

Adobe and Acrobat are trademarks of Adobe Systems Incorporated.

Microsoft®, Windows® and Windows NT® are registered trademarks of Microsoft Corporation in the United States and/or other countries.

Pentium is a registered trademark of Intel Corporation.

Ethernet® is a registered trademark of Xerox Corporation.

Other product names used herein are for identification purposes only and might be trademarks of their respective companies. We disclaim any and all rights in those marks.

Note

The proper names of the Windows operating systems are as follows:

- Microsoft® Windows® 95 operating system
- Microsoft® Windows® 98 operating system
- Microsoft® Windows® Millennium Edition (Windows Me)
- Microsoft® Windows® 2000 Professional
- Microsoft® Windows® 2000 Server
- Microsoft® Windows NT® Server operating system Version 4.0
- Microsoft® Windows NT® Workstation operating system Version 4.0
- Microsoft® Windows NT® Server operating system Version 3.51
- Microsoft® Windows NT® Work station operating system Version 3.51

Manuals for This Machine

The following manuals describe the operational procedures and maintenance of this machine.

To enhance safe and efficient operation of this machine, all users should read and follow the instructions carefully.

❖ **Copy Reference**

Describes the procedures and functions for using this machine as a copier.

❖ **System Settings**

Describes the system settings of this machine.

❖ **Printer Reference 1**

Describes the system settings, procedures and functions for using this machine as a printer.

❖ **Printer Reference 2**

Describes the procedures and provides necessary information about using this machine as a printer. This manual is included as a PDF file on the CD-ROM labeled " Operating Instructions for Printer ".

❖ **Network Printing Guide Operating Instructions**

Describes the procedures and provides necessary information about setting up and using the printer under the network environment. We recommend this manual as your first choice, and it is included as a PDF file on the CD-ROM labeled " Operating Instructions for Printer ".

❖ **PostScript 3 Unit Type 1045 Operating Instructions Supplement**

Describes the menus and features you can set using the PostScript printer driver. This manual is provided as a PDF file on the CD-ROM labeled " Operating Instructions for Printer ".

❖ **UNIX Supplement**

Provides information about setting up and using the printer in a UNIX environment. This manual is included as a PDF file on the CD-ROM labeled " Operating Instructions for Printer ".

❖ **Scanner Reference**

Describes the procedures and functions for using this machine as a scanner.

❖ **Network TWAIN Scanner Reference**

Describes the procedures and provides necessary information about using this machine as a network scanner. This manual is included as a PDF file on the CD-ROM labeled " Operating Instructions for Printer ".

How to Read This Manual

Symbols

In this manual, the following symbols are used:

Important

If this instruction is not followed, paper might be misfed, originals might be damaged, or data might be lost. Be sure to read this.

Preparation

This symbol indicates the prior knowledge or preparations required before operating.

Note

This symbol indicates precautions for operation or actions to take after misoperation.

Limitation

This symbol indicates numerical limits, functions that cannot be used together, or conditions in which a particular function cannot be used.

Reference

This symbol indicates a reference.

[]

Keys that appear on the machine's panel display.

Keys and buttons that appear on the computer's display.

[]

Keys built into the machine's operation panel.

Keys on the computer's keyboard.

Names of Major Options

Major options of this machine are referred to as follows in this documentation.

- Printer/Scanner unit type 1045→printer/scanner unit
- Network Interface Board1045→network board

For other options, see the respective documentation.

The following software products are referred to using a general name.

- ScanRouter V2 Lite and ScanRouter V2 Professional → ScanRouter V2 Lite/Professional

TABLE OF CONTENTS

1. Network Scanner

Outline	1
Network Delivery Scanner.....	1
Network TWAIN Scanner	3
Storing Scan Data	4
Software	6

2. Before Use

Scanner Interface	9
Connecting to the Network	10
Reading the Indicators	10
Names and Functions of Controls	11
Control Panel	11
Display Contents	12
Common Key Operations.....	13

3. Preparations for Use as a Network Scanner

Preparation Sequence	15
Using as a Network Delivery Scanner.....	15
Using as a Network TWAIN Scanner	16
Storing Scan Data	17
Default Settings	18
Settings Made with ScanRouter V2 Lite/Professional	20
Software and Manuals Supplied on CD-ROM	22
List of Files	22
TWAIN Driver Ver.3	22
Network Delivery Scanner Software	23
Instruction Manuals and Help Files	26
Software Installation Sequence.....	27

4. Initial Scanner Setup

Setting the Timer Function of the Scanner (System Settings: Clock Timer Setup)	31
Settings	31
Setting the Network Environment (System Settings: Interface Setup)	32
Settings	32
Network Environment Settings	34
Settings	34
Making Scanner Settings < Scanner Features : Basic Settings >	35

Settings	35
Setting Procedure	37
Making Scanner Settings <Scanner Features: Scanner Settings >.....	40
Settings	40
Setting Procedure	43
Making Scan Data Subject Settings <Scanner Initial Features: Subject Settings >	44
Settings	44
Setting Procedure	44

5. Scanning an Original

Original Setting.....	47
Original Orientation and Scan Area Setting	48
Setting the Original on the Exposure Glass	51
Setting the Original in the Automatic Document Feeder (ADF)	52
Using as a Network Delivery Scanner	54
List Display of Destinations and Senders.....	54
Delivery Procedure.....	55
Checking the Delivery Result	59
Storing Scan Data in the Document Server	61
Store Procedure	62
Using the Network TWAIN Scanner Function.....	66

6. Delivering/Managing Stored Scan Data

Viewing a List of Stored Files.....	67
Viewing the List.....	68
Searching for Files	69
Delivering Stored Files.....	71
Deleting Stored Files.....	72
Changing File Information	73

7. Appendix

Troubleshooting	75
Delivery Function Does Not Work	75
Scanning Does Not Work Properly	75
Error Message is Displayed	76
Instructions for Powering Off the Machine	80
Turning Off the Power	80
Turning Off the Main Power	80
Important.....	82
Specifications	83
INDEX.....	84

1. Network Scanner

Outline

By installing the printer/scanner unit, the machine can be used as a network scanner.

The network scanner offers three functions: operation as a network delivery scanner, network TWAIN scanner, or storing scan data in the machine itself.

This section gives an outline of the three functions and explains the software required to use the network scanner.

Network Delivery Scanner

When used as a network delivery scanner, the machine delivers scan data to a specified destination selected from a list of destinations programmed in the delivery server. This requires that ScanRouter V2 Lite or ScanRouter V2 Professional (sold separately) is installed on the delivery server on the network.

Scan data can also be stored in the machine and selected later for repeated delivery.

Reference

For information about the store scan data function, see P.4 “Storing Scan Data”.

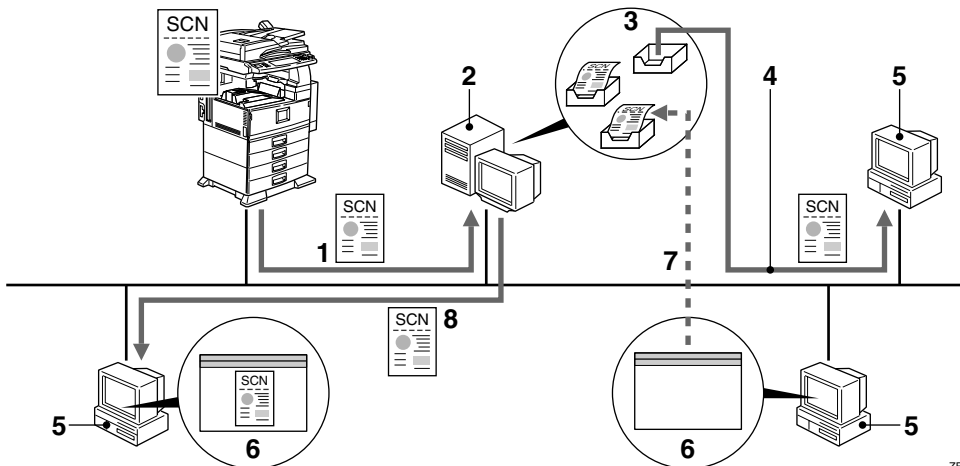

1. Scan data

Specify destination and scan document.

Send scan data to the delivery server.

2. Delivery processing by delivery server

Server on which ScanRouter V2 Lite/Professional is installed. Delivers scan data to the devices on network. Using the ScanRouter V2 Administration Utility, destinations and sender names are stored in an address book format, and delivery options can be selected individually for each destination. The ScanRouter V2 Administration Utility allows setting the following delivery options.

- In-Tray save
Scan data is saved in the in-tray of the delivery server.
- Save as Windows file
Scan data is saved in a specified folder on a computer on the same network as the delivery server.

Note

- The optional ScanRouter V2 Professional provides the following additional functions. For details, see the ScanRouter V2 Professional documentation.
 - Deliver scan data as an e-mail attachment
 - Deliver scan data with DeskTopBinder V2
 - View scan data with web browser or download to a client computer

3. Save scan data in an in-tray

The in-tray is created on destinations programmed with the ScanRouter V2 Administration Utility. Data sent from the machine is saved according to settings made with the ScanRouter V2 Administration Utility.

4. File arrival signaling and file retrieval with the ScanRouter V2 Lite/Professional

The ScanRouter V2 Link (part of DeskTopBinder V2) monitors the in-tray of the delivery server. When scan data is received from the machine, processing takes place according to preset parameters. The following functions are available.

- Receive scan data from in-tray and store in DeskTopBinder V2 work folder
- Receive scan data from in-tray and store in specified folder
- Notify client computer when scan data arrive in in-tray

5. Client computer

6. Edit scan data with DeskTopBinder V2

Software installed on client computer.

Allows viewing of scan data downloaded to the client computer, and also viewing and deleting of scan data saved in the in-tray of the delivery server.

7. Data viewing/erasing/retrieval with DeskTopBinder V2

When saving of scan data in the in-tray was selected with the ScanRouter V2 Administration Utility, and data is not retrieved with ScanRouter V2 Link, data is saved in the in-tray. DeskTopBinder V2 can then be used to view, delete, or retrieve the scan data files in the in-tray.

8. Save in specified folder

According to a setting made with the ScanRouter V2 Administration Utility, scan data sent to the delivery server can be saved in a specified folder.

Network TWAIN Scanner

When the machine is connected to a network, the network TWAIN scanner function allows the machine to be used by any client computer on the network in the same way as a local scanner.

After setting the original on the machine, DeskTopBinder V2 or other TWAIN compliant software can be used on a client where the TWAIN Driver Ver.3 is installed. The software running on the client uses the driver to control scanning of the original, and the result is displayed on the client.

Reference

For information about installing the required software and scanning operation using the TWAIN driver, see the Network TWAIN Scanner Reference.

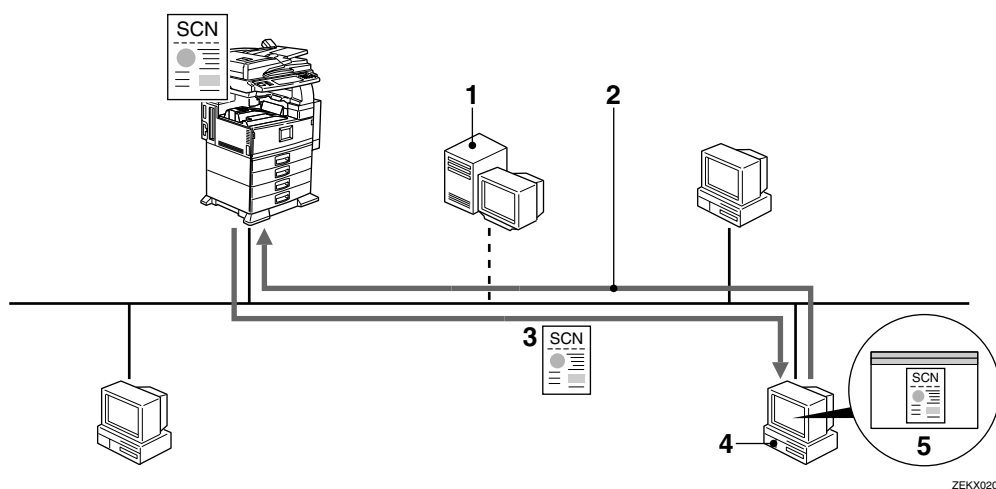

1. Delivery server

Not used when the machine operates as a network TWAIN scanner.

2. Scan command

3. Scan data

4. Client computer

The TWAIN driver is used when scanning the original, to make scan settings and control operation.

5. DeskTopBinder V2

The scanned result can be viewed and edited.

Storing Scan Data

The data of scanned originals can be stored as files in the Document Server of the machine (maximum 3,000 files or 9,000 pages).

Stored scan data can be used as follows.

- Use DeskTopBinder V2 to perform functions such as viewing or deleting scan data in the Document Server.
- Assign user name, document name, and password to each stored scan data file. Manage and search files using the name and other criteria.

Note

- Stored data is preserved also when the main power switch of the machine is turned off or a power failure occurs.
- The maximum store capacity for scan data depends on the amount of data stored with the copy function etc.
- The maximum number of pages per scan data file is 500.

◆ **When using together with a network delivery scanner**

Adding a delivery server with ScanRouter V2 Lite/Professional installed to the network provides the following additional functions.

- Multiple scan data files (up to 30) can be selected, and destination, sender, subject, and delivery sequence can be specified.
- Delivery mode can be set to send only, store only, or simultaneous store and send.

Note

- To deliver stored scan data, a delivery server must be present on the network, and the following conditions apply.
 - ScanRouter V2 Lite/Professional must be installed.
 - The ScanRouter V2 Administration Utility (ScanRouter V2 Lite/Professional) must have been used to program destination and sender information in the delivery server.
- The illustration below refers to operation using stored scan data files. Delivery of stored scan data by a delivery server can be performed in the same way as described in the section about the network delivery scanner function. For details, see P.1 “*Network Delivery Scanner*”.

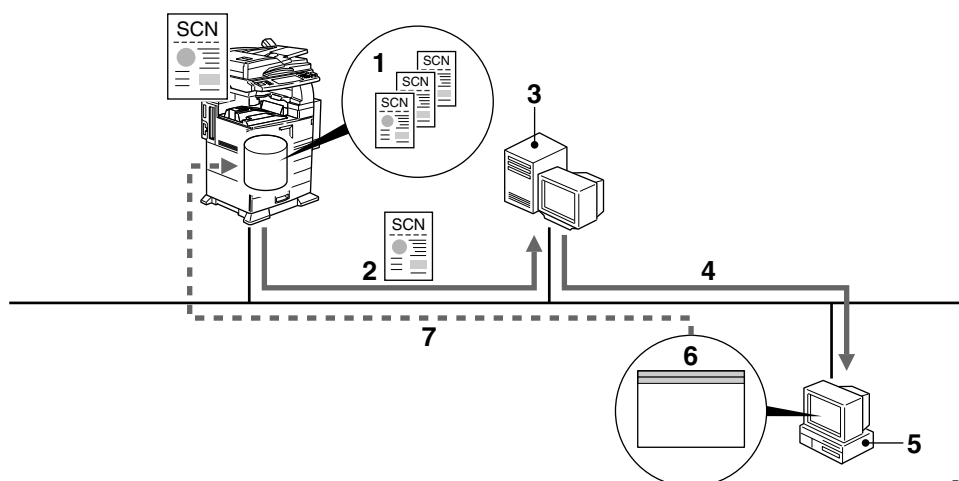

ZEKX030J

1. Scan data files stored on hard disk (Document Server) of the machine

2. Stored file to be delivered

The file selected with operation panel of the machine is sent to the delivery server.

3. Delivery server

Delivers files to other devices on network.

4. Delivery/acknowledge at client computer

According to the delivery method specified with ScanRouter V2 Administration Utility and ScanRouter V2 Link, the client computer receives the file and sends confirmation message to the in-tray of delivery server.

5. Client computer

6. DeskTopBinder V2

Software installed on client computer.

Serves not only for viewing scan data files sent to the client computer, but also for viewing and managing scan data files stored on the Document Server.

7. Scan data viewing/deleting/retrieval with DeskTopBinder V2

DeskTopBinder V2 can be used to view, delete, or retrieve scan data files in a Document Server.

Software

1

This section explains the operation of software required for using the machine as a network scanner. When the machine operates as a network delivery scanner, ScanRouter V2 Lite/Professional, DeskTopBinder V2 software is used. When the machine operates as a network TWAIN scanner, the Ver.3 is used.

ScanRouter V2 Lite/Professional and DeskTopBinder V2

The ScanRouter V2 Lite/Professional and DeskTopBinder V2 are designed to turn paper documents in an office environment into electronic form and share these documents among multiple clients on a network. Adopting the ScanRouter V2 Lite/Professional, DeskTopBinder V2 has the following advantages.

- Documents can be created and shared easily by multiple users.
- Office documents can be stored in the in-tray or on client computers connected to the network.

To operate a network scanner in the ScanRouter V2 Lite/Professional, DeskTopBinder V2, the following software is used.

- ScanRouter V2 Lite/Professional
- ScanRouter V2 Administration Utility
- DeskTopBinder V2
- ScanRouter V2 Link

❖ ScanRouter V2 Lite/Professional

The ScanRouter V2 Lite software for installation on the delivery server is supplied with the machine. The software allows managing the scan data files sent from the machine to the delivery server. Files can be stored in a specified in-tray or in any folder of a client computer on the network.

Note

- ❑ The separately available ScanRouter V2 Professional software adds the following functions.
 - Deliver scan data files as e-mail
Specify whether to notify only or send data as an attachment
 - View and download scan data with a web browser
 - Deliver scan data files from ScanRouter V2 Lite/Professional
 - Deliver files received with the fax function of machine

❖ **ScanRouter V2 Administration Utility**

This is a utility of the ScanRouter V2 Lite which serves to program or change delivery destination and sender information, maintain a log, and perform delivery server maintenance and other tasks. This utility can be installed not only on the delivery server but also on a client computer, allowing remote operation from the client.

Delivery type can be specified separately for each delivery destination.

- **In-Tray save**
Scan data is saved in the in-tray of the delivery server. Data in the in-tray can be viewed, deleted, or retrieved from the client computer using DeskTopBinder V2.
- **Save as Windows file**
Store scan data as a file in any folder on any computer on the same network as the delivery server.

Note

- "Set I/O Device" of ScanRouter V2 Administration Utility must be set to scanner (this machine) beforehand.
- The destination and sender information stored on the delivery server with this utility will be used for file delivery from the machine.

Reference

For details, see the ScanRouter V2 Lite Management Guide or ScanRouter V2 Administration Utility Help.

❖ **DeskTopBinder V2**

This software allows managing different kinds of data (image data from scanners, files created by applications, existing image files, etc.) under a single framework. The software is installed on the client computer. DeskTopBinder V2 Lite is supplied with the machine.

Scan data files sent from the machine to the delivery server and files stored in the Document Server can be viewed. With the supplied TWAIN driver, the machine can be used as a network TWAIN scanner.

Reference

For details, see the DeskTopBinder V2 Lite Help and the Network TWAIN Scanner Reference.

❖ ScanRouter V2 Link

This is a utility for linking DeskTopBinder V2 with ScanRouter V2 Lite/Professional. It monitors the in-tray of the delivery server. When a file arrives, the user can be notified or the file can be retrieved. The monitoring interval, notification method, and file save method can be specified.

When a file arrives in the in-tray, one of the following actions can be carried out.

- **Notify only**
The user is only notified that a file has arrived. The file must be retrieved manually.
- **Notify and retrieve**
The file is automatically retrieved when it arrives in the in-tray. Selectable retrieve options are as follows.
 - **Save in specified folder on client computer**
The file is moved from the in-tray of the delivery server to a specified folder on the client computer.
 - **Store file in DeskTopBinder V2 work folder**
The file is moved from the in-tray of the delivery server to the DeskTopBinder V2 work folder on the client computer.

 Reference

For details, see ScanRouter V2 Link Help.

TWAIN Driver Ver.3

This driver is used to read the data from a scanner. Before using the machine as network TWAIN scanner, the driver must be installed on the client computer where the data is to be read.

When this driver is selected in DeskTopBinder V2 another TWAIN compliant application, and the scanning process is initiated, the driver will start up and perform reading according to the preset conditions.

The driver has various functions, such as superimposing data and page number information, and compensating for character slant.

 Reference

Regarding installation and use of the driver, see the Network TWAIN Scanner Reference.

2. Before Use

This chapter explains how to connect the scanner interface to the network and gives an overview of the operation panel and display.

Scanner Interface

The printer/scanner unit is installed at the rear of the machine, as shown below. The network connection interface of the printer/scanner unit is 10BASE-T and 100BASE-TX compatible. (The selection made is automatically detected.)

 **Note**

- The scanner and printer share the same interface.
- The communication speed can be changed in the System Settings. see the System Settings manual.

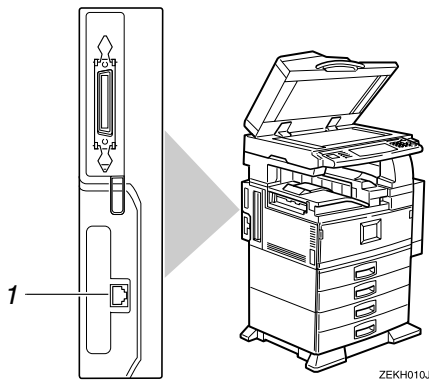

1. Interface connector

Connecting to the Network

The scanner unit is connected to the network using a 10BASE-T or 100BASE-TX network cable. When using 100BASE-TX, the cable should be category 5.

2

- 1** Make sure that the main power switch of the machine is turned off.
- 2** Connect the smachine to the network using a suitable network cable.

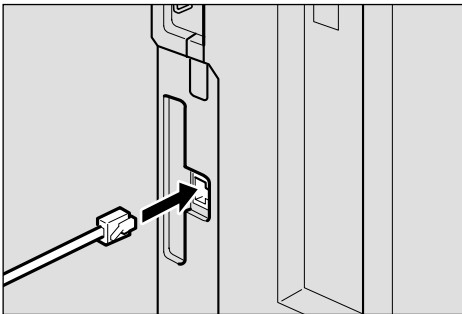

ZEFH030J

- 3** Turn the main power switch of the machine on.

Reading the Indicators

There are two LED indicators on the Ethernet board. These allow you to confirm that the network board is operating correctly.

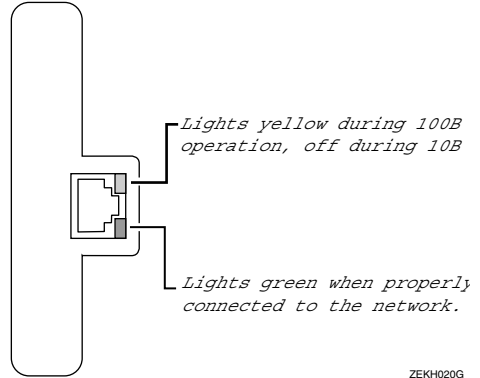

ZEKH020G

Names and Functions of Controls

This section explains the names and functions of various controls used to operate the scanner.

Control Panel

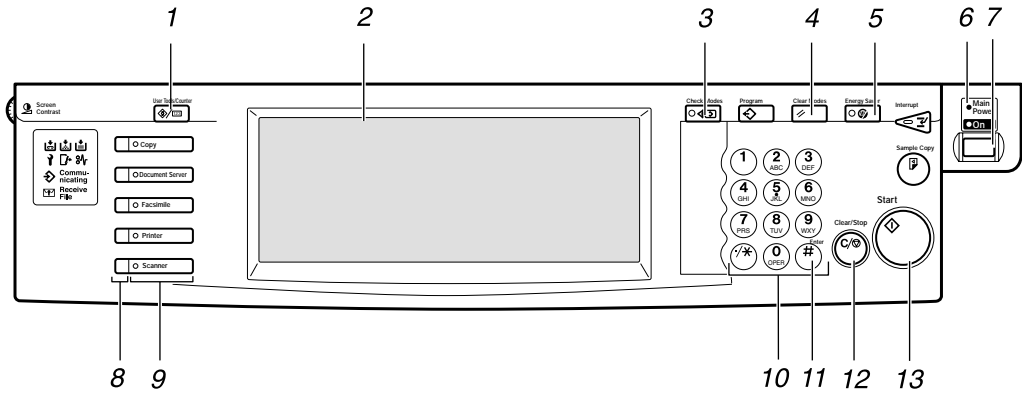

ZEKS0108

1. [User Tools/Counter] key

Use to set default values and change operation parameters.

2. Display

Shows operation status and various messages.

3. [Check Settings] key

Press to check the current settings.

4. [Reset] key

Use to cancel settings.

5. [Warmup] key

Press this key for about 1 second to begin warmup.

Pressing this key again while in warmup mode cancels warmup.

Note

- This key is inactive while scanning or setting scanner default values.

6. Main power indicator

Lights up when the main power switch is set to On.

7. Operation Switch

Pressing this switch turns the machine on. The power indicator lights up. To turn the machine off, press this switch again.

Note

- This key is inactive while setting scanner default values.

8. Status indicators

Show the status of the various functions.

- When lit green, the corresponding function is active.
- When lit red, the corresponding function is interrupted. Press the respective key and follow the instructions that appear on the display.

9. Function keys

Pressing the Copy, Document Server, Fax, Printer, or Scanner key activates the respective function. The display content changes accordingly.

The indicator for the selected function lights up.

10. Number keys

Use to enter numeric values.

11. **【#】 (Enter) key**

Use to enter a numeric value.

12. **【Clear/Stop】 key**

- Clear: Clears an entered numeric value.
- Stop: Stops scanning.

13. **【Start】 key**

Use to begin scanning, file storing, or delivery.

Display Contents

The normal screen configuration is as follows.

The display's contents differ depending on the mode.

Important

- ❑ Protect the display from shocks and strong pressure, to prevent the possibility of damage. The maximum allowable force is 30 N (3 kgf).

*1 :N: Newton

*2 kgf: kilogram-force (1 kgf = approx. 9.8 N)

Note

- ❑ The "Copy" screen is set as the default screen for when the machine is turned on. You can change this setting under the **【Basic Settings】** tab in System Settings.

Network delivery scanner

- The "Delivery Option" may be set to "Yes" in some cases.
- Selected or specified items are highlighted.

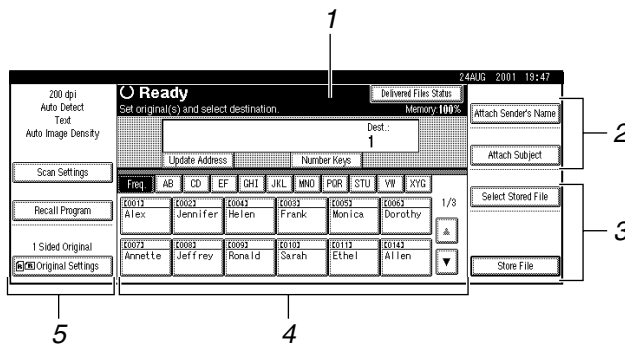

1. Shows operation information or error messages.

2. Use to change or display sender name and subject information.

3. Use to change or display file storage settings.

4. Shows a table of delivery destinations.

5. Shows scanning settings, original set status, and items that can be changed.

Network TWAIN scanner and store scan data display

When using the machine as a network TWAIN scanner, it is not necessary to select **[Scanner]** on the operation panel. When the TWAIN driver becomes active on a client computer, the display automatically switches to the following screen.

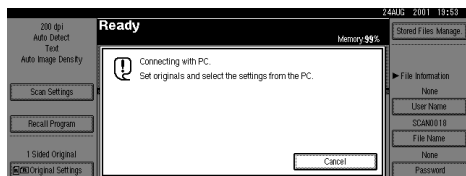

Selecting **[Cancel]** displays the store scan data screen.

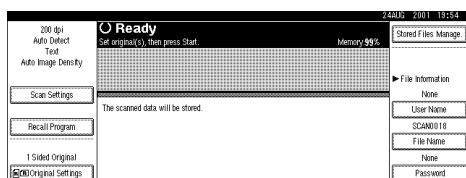

Note

- When the scanner default setting for "Delivery Option" is "Yes", the network delivery scanner screen appears. ⇒ P.12 "Network delivery scanner"

Common Key Operations

The following keys are common for all screens.

◆ Key list

[OK]	Confirms the selected function or input value, and returns to the previous screen.
[Cancel]	Cancels the selected function or input value, and returns to the previous screen.
[▲Prev.] [▼Next]	Displays the next or previous page when functions will not fit on a single page.
[Exit]	Exits the message screen.
[Clear]	Clears the entered value and returns to the previous conditions. The screen displayed does not change.
[Exit]	Confirms the selected function or input value then returns to the previous screen.

3. Preparations for Use as a Network Scanner

Preparation Sequence

The preparation sequence is different depending on whether the machine is to be used as a network delivery scanner or network TWAIN scanner, or to store scan data files.

Using as a Network Delivery Scanner

The preparation sequence to use the machine as a network delivery scanner is as follows.

① Connect to Network

Connect the machine to the network with an Ethernet cable.
⇒ P.10 *"Connecting to the Network"*



② Make System Settings

Check the network settings in System Settings, and change if required.
Make scan settings, enter subjects, and make other settings for the network delivery scanner function.
⇒ P.i *"PostScript 3 Unit Type 1045 Operating Instructions Supplement"*



③ Install Software

On the client computers and delivery server, install the software and utilities required for using the network delivery scanner function.
⇒ P.27 *"Software Installation Sequence"*



④ Set Destination and Sender Information

Set the destination and sender information using the ScanRouter V2 Administration Utility.
ScanRouter V2 Lite Management Guide



Note

- ❑ After installing the required software on the delivery server, make the required settings for server maintenance and set up the server to be used for delivery. ⇒ P.20 *"Settings Made with ScanRouter V2 Lite/Professional"*

Using as a Network TWAIN Scanner

The preparation sequence to use the machine as a network TWAIN scanner is as follows.

1 Connect to Network

Connect the machine to the network with an Ethernet cable.
⇒ P.10 *"Connecting to the Network"*



2 Make System Settings

Check network settings in System Settings, and change if required.
⇒ P.i *"PostScript 3 Unit Type 1045 Operating Instructions Supplement"*



3 Install Software

On the client computers, install the TWAIN driver, DeskTop-Binder V2 Lite and other software required for using the network TWAIN scanner function.
⇒ P.27 *"Software Installation Sequence"*

Storing Scan Data

The preparation sequence to store scan data files in the Document Server of the machine is as follows. When stored files are to be managed from a client computer, perform steps ① to ③. When using the network delivery scanner function, perform steps ① to ⑤. Make preparations according to the network environment.

① Connect to Network

Connect the machine to the network with an Ethernet cable.
⇒ P.10 *"Connecting to the Network"*

② Make System Settings

Check the network settings in System Settings, and change if required.
Make scan settings, enter subjects, and make other settings for the store scan data function.
⇒ P.i *"PostScript 3 Unit Type 1045 Operating Instructions Supplement"*

③ Install Software

On the client computers, install DeskTopBinder V2 Lite and other software required for managing stored Document Server files.
⇒ P.27 *"Software Installation Sequence"*

④ Install Delivery Software

On the delivery server, install ScanRouter V2 Lite and other software required for using the network delivery scanner function. After installing the software, make the required settings for server maintenance and set up the server to be used for delivery.
⇒ P.27 *"Software Installation Sequence"*
⇒ P.20 *"Settings Made with ScanRouter V2 Lite/Professional"*
ScanRouter V2 Lite Management Guide

⑤ Set Destination and Sender Information

Set the destination and sender information using the ScanRouter V2 Administration Utility.
⇒ ScanRouter V2 Lite Management Guide
⇒ ScanRouter V2 Administration Utility Help

Default Settings

This section explains all required settings for using the machine as a network scanner.

When using the machine as a network delivery scanner, network TWAIN scanner, or for storing scan data files, various system settings and Scanner Settings must be made as listed below.

3

Settings		Delivery ^{*1}	TWAIN ^{*2}	Store scan data ^{*3}	
System settings	Clock timer settings	Scanner Auto Reset Timer	<input type="radio"/>	<input type="radio"/>	
	Interface settings [Network]	IP Address	☆	☆	☆
		Sub-net Mask	<input type="radio"/>	<input type="radio"/>	<input type="radio"/>
		Sub-net Mask	<input type="radio"/>	<input type="radio"/>	<input type="radio"/>
		Gateway Address		<input type="radio"/>	
		Access Mask		<input type="radio"/>	
		Network Boot		<input type="radio"/>	
		Valid protocol	<input type="radio"/> ^{*4}	<input type="radio"/> ^{*4}	<input type="radio"/> ^{*4}
	Ethernet Speed	<input type="radio"/>	<input type="radio"/>		
	File transfer settings	Delivery Server IP Address	☆		
		Resend interval setting	<input type="radio"/>		
		Resend frequency setting	<input type="radio"/>		

Settings		Delivery ^{*1}	TWAIN ^{*2}	Store scan data ^{*3}	
Scanner Features	Basic Settings	Resolution	<input type="radio"/>		<input type="radio"/>
		Scan Size	<input type="radio"/>		<input type="radio"/>
		Scan Type	<input type="radio"/>		<input type="radio"/>
		Image Density	<input type="radio"/>		<input type="radio"/>
	Scanner Settings	Function Priority	<input type="radio"/>	<input type="radio"/>	<input type="radio"/>
		Delivery/Store Connection Time out	<input type="radio"/>	<input type="radio"/>	<input type="radio"/>
		Compression (Black & White)	<input type="radio"/>	<input type="radio"/>	<input type="radio"/>
		Compression (Gray Scale)	<input type="radio"/>	<input type="radio"/>	<input type="radio"/>
		Delivery Option	☆		
		Original Setting	<input type="radio"/>		<input type="radio"/>
		Original Orientation Priority	<input type="radio"/>		<input type="radio"/>
		Mixed Original Sizes Priority	<input type="radio"/>		<input type="radio"/>
	SADF Auto Reset Timer	<input type="radio"/>		<input type="radio"/>	
Subject Settings		<input type="radio"/>			

^{*1} Settings for use as network delivery scanner

^{*2} Settings for use as network TWAIN scanner

^{*3} Settings for storing scan data

^{*4} This setting cannot be changed. It must be left at the factory default value.

Important

- Items marked (☆) are the minimum required settings for using the machine as a network scanner. Be sure to set these items before use.
- Items marked (○) should be set as required.

Settings Made with ScanRouter V2 Lite/Professional

The ScanRouter V2 Lite/Professional software is installed on the delivery server. It performs functions such as sorting files sent from the machine, storing files in a specified in-tray, or storing them in a folder on a computer in the same network.

To use the machine as a network delivery scanner, information about scan data file destinations and senders must be programmed in the delivery server using the ScanRouter V2 Administration Utility. The ScanRouter V2 Administration Utility is a utility of ScanRouter V2 Lite/Professional. Use it to change destination and sender information and perform delivery server maintenance and other tasks.

To use the machine as a network delivery scanner, make the following settings with the ScanRouter V2 Administration Utility.

❖ Document delivery settings

- Program scanner for use
- Program/change destination and sender information

Note

- With the ScanRouter V2 Administration Utility, a user specified as a destination can also be specified as a sender.
- A list of programmed destinations and senders is shown on the operation panel of the machine when sending a file from the machine. ⇒ P.54 *"List Display of Destinations and Senders"*
- Change destination and sender subject information
- Destination-specific delivery patterns
When sending a file from the machine, the delivery pattern used by the delivery server can be specified.
 - In-Tray save
A separate in-tray is created on the delivery server for each destination, and a file sent from the machine to that destination is placed in that in-tray. Files saved in a tray can be managed (viewed or deleted) with DeskTopBinder V2 running on a client computer. ScanRouter V2 Link can be used to notify a client computer of the arrival of a file, or to automatically retrieve the file.
 - Save as Windows file
The file is stored in a specified folder on a computer in the same network.

❖ **Delivery server maintenance settings**

- Error log
- Monitor free disk space on the delivery server
- Delivery failure management
- Administrator notification in case of error

Reference

For information about the use of the ScanRouter V2 Administration Utility, see its help function.

Software and Manuals Supplied on CD-ROM

The machine comes with two CD-ROMs containing various software.

The CD-ROM labeled "Printer Driver & Utilities" contains the necessary software to use the machine as a printer. The CD-ROM labeled "Scanner Driver & Document Management Utilities" contains the necessary software to use the machine as a network scanner.













This section explains the software, help files, and manual files contained on the "Scanner Driver & Document Management Utilities" CD-ROM.

3

Reference

For information about the software, help files, and manual files contained on the "Printer Driver & Utilities" CD-ROM, see the System Settings manual.

List of Files

 CD-ROM Drive	 Wizard for the TWAIN driver and utilities			
	 Drivers	 TWAIN	TWAIN driver for Windows 95/98/Me, Windows 2000, Windows NT 4.0 and Windows NT 3.51	
	 UTILITY	 ROUTERV2	 ScanRouter V2 Lite  ScanRouter V2 Administration Utility	
		 DESK V2	 DeskTopBinder V2 Lite  Job Binding  ScanRouter V2 Link	
	 Acrobat	Acrobat Reader 4.05		

TWAIN Driver Ver.3

This driver is required to scan an original on a scanner. The driver should be selected in the device selection menu of the TWAIN compliant application. The driver will then start up automatically whenever scanning is initiated.

The driver has various functions, such as superimposing data and page number information, and compensating for character slant.

To use the machine as a network TWAIN scanner, the driver must be installed.

❖ File storage folder

Files on the CD-ROM are contained in the following folder.

- \DRIVERS\TWAIN

Note

- ❑ The same TWAIN driver is used for Windows 95/98/Me, Windows 2000, Windows NT 4.0, and Windows NT 3.51.

❖ Environment

- Compatible operating systems
 - Microsoft® Windows® 95
 - Microsoft® Windows® 98
 - Microsoft® Windows® 98 Second Edition
 - Microsoft® Windows® Millennium Edition
 - Microsoft® Windows® 2000 Server
 - Microsoft® Windows® 2000 Professional
 - Microsoft® Windows NT® Server 4.0 (with Service Pack 5 or higher)
 - Microsoft® Windows NT® Workstation 4.0 (with Service Pack 5 or higher)
 - Microsoft® Windows NT® Server 3.51 (with Service Pack 5 or higher)
 - Microsoft® Windows NT® Workstation 3.51 (with Service Pack 5 or higher)
- Hardware
 - PC/AT compatible capable of running one of the above OSs

📍 Limitation

- Under Windows NT, machines with RISC-based processor (MIPS R series, Alpha AXP. Power PC) are not compatible.
- Display resolution
 - 800 x 600 pixels, 256 colors or higher

Network Delivery Scanner Software

ScanRouter V2 Lite

ScanRouter V2 Lite is to be installed on the delivery server. Scanned data can be sorted and stored in specified in-trays, or saved in folders of client computers on the same network.

❖ File storage folder

The files are stored in the following folder on the CD-ROM provided with this machine.

`\UTILITY\ROUTERV2`

❖ System Requirements

The following system requirements must be met to use ScanRouter V2 Lite.

📝 Note

- Install the software on a stand-alone server running Windows NT Server or Windows 2000 Server. It must not be installed on the primary domain controller or backup domain controller.
- Hardware
 - PC/AT compatible
- CPU
 - Pentium 200 MHz or faster (Pentium II 350 MHz or faster recommended)

- Operating system
 - Microsoft® Windows® 95 (OSR 2 or later)
 - Microsoft® Windows® 98
 - Microsoft® Windows® 98 Second Edition
 - Microsoft® Windows® Millennium Edition
 - Microsoft® Windows® 2000 Server
 - Microsoft® Windows NT® Server 4.0 (with Service Pack 5 or higher)
- Memory
 - 64 MB or more (128 MB or more recommended)
- Hard disk space
 - Minimum free space required for installing: 200 MB

 **Note**

- In addition to the space required for installation, the hard disk should have at least 500 MB of free space for files.

- Network protocol
 - TCP/IP

❖ **Utility (ScanRouter V2 Administration Utility)**

ScanRouter V2 Administration Utility, manages the delivery system run by ScanRouter V2 Lite. This utility is to be installed with ScanRouter V2 Lite on the delivery server.

To sort scanned documents in the delivery server, you can register destination and sender information in an address book in the delivery server. In addition, this utility can monitor free disk space, record error logs and maintain the delivery server.

 **Note**

- ScanRouter V2 Administration Utility can be installed not only on the delivery server but also on client computers. To install it, click **[ScanRouter V2 Lite] [ScanRouter V2 Administration Utility]** on the ScanRouter V2 Lite setup screen.

 **Reference**

For information about the setup procedure using the ScanRouter V2 Administration Utility, see the ScanRouter V2 Lite Management Guide.

DeskTopBinder V2 Lite

DeskTopBinder V2 Lite is to be installed on the client computers for integration and management of various kinds of data such as scanned image data, files created with applications, and existing image files.

This software allows you to view documents in in-trays. In addition, by installing the TWAIN driver provided, this machine can be used as a network TWAIN scanner.

For details, see the DeskTopBinder V2 Lite Introduction Guide or DeskTopBinder V2 Lite Help.

◆ File storage folder

The files are stored in the following folder on the CD-ROM provided with this machine.

`\UTILITY\DESKV2`

◆ System requirements

The following system requirements must be met to use DeskTopBinder V2 Lite.

- Hardware
PC/AT compatible
- CPU
Pentium 133 MHz or faster (Pentium II 266 MHz or faster recommended)
- Operating system
Microsoft® Windows® 95 (OSR 2 or later)
Microsoft® Windows® 98
Microsoft® Windows® 98 Second Edition
Microsoft® Windows® Millennium Edition
Microsoft® Windows® 2000 Server
Microsoft® Windows® 2000 Professional
Microsoft® Windows NT® Server 4.0 (with Service Pack 5 or higher)
Microsoft® Windows NT® Workstation 4.0 (with Service Pack 5 or higher)
- Memory
48 MB or more (64 MB or more recommended)
- Hard disk space
50 MB or more (200 MB or more recommended)
- Display resolution
800 x 600 pixels, 64k colors or higher

◆ Utility (ScanRouter V2 Link)

ScanRouter V2 Lite, a utility of DeskTopBinder V2 Lite, is to be installed on client computers with the software, DeskTopBinder V2 Lite.

With ScanRouter V2 Lite, in-trays in the delivery server are monitored regularly from the client computer. In addition, when a document arrives in an in-tray of the delivery server, a notification of document arrival can be received at the client computer or the document can be retrieved to the client computer.

Instruction Manuals and Help Files

The "Scanner Driver & Document Management Utilities" CD-ROM contains help files and the following instruction manuals.

Note

- ❑ To view files in PDF format, the Adobe Acrobat Reader is required. The Reader can be installed from the "Scanner Driver & Document Management Utilities" CD-ROM.

❖ **Network TWAIN Scanner Reference**

This manual in PDF format contains instructions for installing the TWAIN driver, performing scanning and editing with DeskTopBinder V2, and using the machine as a network TWAIN scanner.

❖ **DeskTopBinder V2 Lite Setup Guide**

These instructions in PDF format are displayed when installing DeskTopBinder V2.

They appear when you click **[Setup Guide]** on the "Set up DeskTopBinder V2 Lite" screen of the installer. The instructions explain the operating environment details for DeskTopBinder V2 Lite and the installation procedure.

❖ **DeskTopBinder V2 Lite Introduction Guide**

A link to these instructions in PDF format is added to the Start menu when installing DeskTopBinder V2.

For operating information, see DeskTopBinder V2 Help.

❖ **ScanRouter V2 Link Guide**

A link to these instructions in PDF format is added to the Start menu when installing DeskTopBinder V2 Lite.

They explain the operation and features of ScanRouter V2 Link.

❖ **ScanRouter V2 Lite Setup Guide**

These instructions in PDF format are displayed when installing ScanRouter V2 Lite.

They appear when you click **[Setup Guide]** on the "Set up DeskTopBinder V2 Lite" screen of the installer. The instructions explain the operating environment details for ScanRouter V2 Lite, the installation of ScanRouter V2 Lite and the delivery server setup procedure.

❖ **ScanRouter V2 Lite Management Guide**

A link to these instructions in PDF format is added to the Start menu when installing ScanRouter V2 Lite.

They contain a function outline for ScanRouter V2 Lite and explain delivery server maintenance using the ScanRouter V2 Administration Utility.

Operation of the ScanRouter V2 Administration Utility is explained in ScanRouter V2 Administration Utility Help.

Software Installation Sequence

Installation under Windows 95/98/Me, Windows 2000, and Windows NT4.0 uses the Auto Run feature. An example for operation under Windows 98 is given below. Operation under Windows 95/Me, Windows 2000, and Windows NT4.0 is similar.

Limitation

- Close all other applications before starting the installation.
- When performing the installation under Windows 2000, Windows NT4.0, and Windows NT 3.51, log on as a member of the Administrators group.
- Under Windows NT 3.51, installation using the Auto Run feature is not possible. For information about how to perform the installation, see the Network TWAIN Scanner Reference.

Auto Run Feature

When the CD-ROM is inserted under Windows 95/98/Me, Windows 2000, or Windows NT4.0, the Auto Run feature automatically starts the installation process for the TWAIN driver and the various utilities.

Note

- Auto Run might not automatically work with certain OS settings. In this case, launch "CDLaunch.exe" located in the CD-ROM root directory.
- If you want to cancel Auto Run, hold down the **[Shift]** key (when your system is Windows 2000, hold down the left **[Shift]** key) while inserting the CD-ROM. Keep the **[Shift]** key held down until the computer has finished accessing the CD-ROM.

Limitation

- Under Windows NT 3.51, installation using the Auto Run feature is not possible. For information about how to perform the installation, see the Network TWAIN Scanner Reference.

The installation sequence using Auto Run is as follows.

Installation Sequence

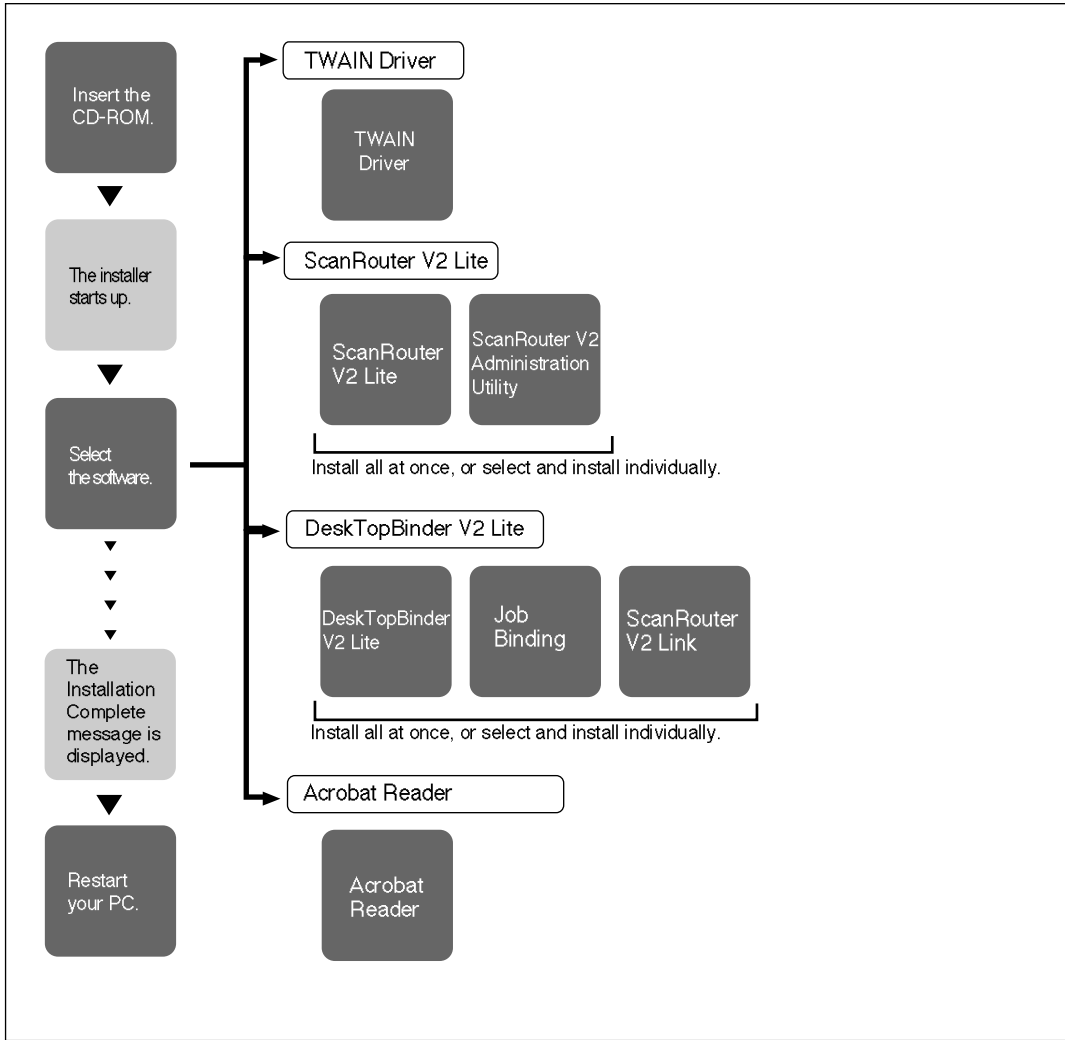

Installation (Windows 95/98/Me, Windows 2000, Windows NT 4.0)

1 Verify that Windows is running. Insert the supplied CD-ROM labeled "Scanner Driver & Document Management Utilities" into the CD-ROM drive of the computer.

The "Choose Setup Language" screen appears. Select a language, and then click [OK].

The installer starts.

2 Click the button of the software to be installed.

The "Change the language to be used by this component" screen appears. Select a language, and then click **[OK]**.

The software setup screen is displayed.

 **Reference**

For further information, see the documentation for the respective software or the Setup Guide that can be displayed from the setup screen.

If the setup screen contains a button marked **[Read This First]** or **[Setup Guide]**, display this information first, before starting the setup procedure.

Installation (Windows NT 3.51)

For information about how to perform the installation under Windows NT 3.51, see the Network TWAIN Scanner Reference.

 **Note**

- DeskTopBinder V2 Lite and ScanRouter V2 Lite are not compatible with Windows NT 3.51.

4. Initial Scanner Setup

To use the machine as a network scanner, you must make basic network environment settings in addition to the Scanner Settings.

To make the basic settings such as timer setup and network environment settings, see the System Settings manual. Then proceed to the detailed network Scanner Settings.

Setting the Timer Function of the Scanner (System Settings: Clock Timer Setup)

This section explains only the settings of the machine's timer that affect scanner operation.

Reference

For information about making system settings, see the System Settings manual.

Note

- If "No" is selected here, the user code input screen also does not appear automatically.

Settings

The following clock timer settings affect operation of the machine as a network delivery scanner. Make the settings as required.

◆ Scanner auto reset timer

This specifies the time-out interval when making destination, sender, and scan settings in the network delivery scanner or for the scan data store functions. If no input is made during this interval, the procedure is aborted.

- When "Yes" is selected, enter the number of seconds until time-out (10 - 999).
- When "No" is selected, no time-out occurs.

The factory default is "60 seconds".

Setting the Network Environment (System Settings: Interface Setup)

To use the machine as a network scanner, the system interface settings must have been made correctly.

Before starting to use the machine, check whether the interface settings are correct.

Important

- ❑ These settings should only be made by the network administrator, or under supervision of personnel charged with network management.

Reference

For information about making system settings, see the System Settings manual.

Settings

The following interface settings affect operation of the machine as a network delivery scanner. Make the settings as required.

❖ IP address

This is the IP address of the machine on the network. This setting is mandatory.

Specify the address in the format "xxx.xxx.xxx.xxx" where x is a numeral.

The factory default is "011.022.033.044".

Note

- ❑ Take care that the IP address set is not the same as the address of another device on the network. If this happens, the machine will not work. Be sure to check with the network administrator before setting the IP address.

❖ Subnet mask

This is a mask for using part of the IP address as the network address. Make the setting if the subnet mask function is to be used.

Specify the address in the format "xxx.xxx.xxx.xxx" where x is a numeral.

The factory default is "000.000.000.000".

Note

- ❑ If you do not know the required setting, leave this item at the factory default.

❖ Gateway address

This is the host and router address to be used for communication (printing, information exchange) with a workstation on another network.

Set this item if the machine is to be used from another network client. Specify the address in the format "xxx.xxx.xxx.xxx" where x is a numeral.

The factory default is "000.000.000.000".

Note

- ❑ If you do not know the required setting, leave this item at the factory default.

❖ Access control and access mask

These settings control which clients can access the machine. The access control setting and access mask setting work in combination.

- The access control address is an IP address to control the use of the machine.
- The access mask setting is used when checking the IP address of a client that attempts to control the machine. The setting is the basis for access control.

Specify the address in the format "xxx.xxx.xxx.xxx" where x is a numeral.

The factory default is "000.000.000.000".

Note

- If access to the machine is not to be limited, leave these items at the factory default.
- Access to the machine is allowed when the result of masking access control matches the result of masking the IP address of the client that attempts to use the machine.
- Acceptable client addresses depend on the access mask specification. (xxx can be any number.) For example, if 192.168.15.16 has been specified as the access control address, acceptable client addresses will be as shown in the table below.

Access mask address	Accessible client addresses
000.000.000.000	xxx.xxx.xxx.xxx
255.000.000.000	192.xxx.xxx.xxx
255.255.000.000	192.168.xxx.xxx
255.255.255.000	192.168.15.xxx
255.255.255.255	192.168.15.16

❖ Network boot

Select the method for setting the IP address of the machine from the client side. Before making or changing this setting, consult the network administrator to make sure that the setting matches the network environment.

- NONE
- DHCP

The factory default is NONE.

Reference

For details, see the System Settings manual.

❖ Valid protocol

Select the protocol to be used on the network.

- TCP/IP : Enable/Disable
- NetWare : Enable/Disable
- NetBEUI : Enable/Disable
- AppleTalk : Enable/Disable

As the factory default, all protocols are enabled.

❖ Ethernet speed

Selects the communication speed of the network.

- Auto select
- Fixed to 100 Mbps
- Fixed to 10 Mbps

The factory default is "Auto select".

Reference

For detailed information about network settings, see the System Settings manual.

Network Environment Settings

To use the machine as a network delivery scanner, the file transfer settings under System Settings must have been made correctly.

Before starting to use the machine, check whether the file transfer settings are correct.

Important

- These settings should only be made by the network administrator, or under the supervision of personnel charged with network management.

Reference

For details on how to make system settings, see the System Settings manual.

Settings

The following file transfer settings affect operation of the machine as a network delivery scanner.

❖ Delivery server IP address

This is the address of the delivery server in the network environment where the machine is connected. Specify the address in the format "xxx.xxx.xxx.xxx" where x is a numeral.

The factory default is "000.000.000.000".

Note

- Be sure to check with the network administrator before setting the IP address.

❖ Resend interval setting

Sets the time interval until delivery is retried if the delivery of scan data to the delivery server has failed.

- If set to "No", delivery is not retried.
- If set to "Yes", enter the time interval in seconds (60 - 999) with the number keys.

The factory default is "300 seconds".

❖ Resend frequency setting

Sets the number of delivery retry attempts.

- If set to "No", delivery is not retried.
- If set to "Yes", enter the number (1 - 99) with the number keys.

The factory default is "3 times".

Note

- If "No" was selected, or if delivery could not be carried out within the specified number of retries, the file delivery result is recorded as "Error" and the file is stored in the machine. However, files not set to be stored will be deleted. ⇒ P.59 "Checking the Delivery Result"

Making Scanner Settings < Scanner Features : Basic Settings >

Various scanning parameters (image density, scan type, resolution, scan size) can be set here. When using the same type of original repeatedly, storing the required settings as a named set makes them easy to select whenever you want to deliver scan data.

Note

- Six sets of scan settings named "Initial Setup" and "Program 1" - "Program 5" can be stored for quick recall. The settings stored as "Initial Setup" are the defaults which will be used if no parameter settings are made when initiating scan data delivery.
- "Program 1" - "Program 5" can be changed to any name of up to 16 characters.

Settings















The scan settings consist of four items.

❖ Resolution

Set the resolution to 100 dpi, 200 dpi, 300 dpi, 400 dpi, or 600 dpi.

❖ Scan Size

Select the size of the original to be scanned.

- Auto Detect
The auto detect function of the machine is used to set the original size.
- A3 , A4 , A4 , A5 , A5 , 11x17 , 8¹/₂x14 , 8¹/₂x13 , 8¹/₂x11 , 8¹/₂x11 , 5¹/₂x8¹/₂ , 5¹/₂x8¹/₂ , B4 , B5 , B5 , Custom Size

When the size is specified, scanning is performed for that size, regardless of the actual size of the original.

Note

- When "Custom Size" is selected, the dimensions of the scan area (width and height) can be specified in millimeters.

❖ Scan Type

Set the scan method suitable for the original. The factory default is "Text".

- Text
Standard original containing mainly text.
- Text/Photo
Original containing a mixture of text and photographs
- Photo
Original containing photographs and other pictures (2-value)
- Gray Scale
Original containing photographs and other pictures (multi-value)

 **Note**

- When "Photo" is selected, the image is read as a 2-value (black-and-white) representation. When "Gray Scale" is selected, the image is read as a multi-value (gray-scale) representation. As a general rule, scanning for printing purposes is best done with the "Photo" setting and scanning for display on a computer with the "Gray Scale" setting.

4

❖ **Image Density**

Set the image density for scanning. The setting can be made in seven steps, from "light" (1) to "dark" (7). The factory default is the center of the range.

Relationship between resolution and original size

Depending on the size of the original, it may not be possible to select the higher resolution settings.

If attempting to make an invalid setting, the message "Exceeded max. data capacity. Check the scanning resolution." is shown on the operation panel. Change the settings to a valid combination.

The relationship between resolution and original size is as follows.

❖ **When "Text", "Text/Photo" or "Photo" is selected as the scan type**

All combinations up to DLT/A3 (297mm×432mm) and 600 dpi are possible.

❖ **When "Grayscale" is selected as the scan type**

Combinations marked (○) in the table are possible.

- Machine used as network TWAIN scanner

	100dpi	200dpi	300dpi	400dpi	600dpi
A3	○	○			
B4	○	○			
A4	○	○	○		
B5	○	○	○		
A5	○	○	○	○	
B6	○	○	○	○	
A6	○	○	○	○	○
A7	○	○	○	○	○
11x17	○	○			
Legal (8 ¹ / ₂ ×14)	○	○			
8 ¹ / ₂ ×13	○	○			
Letter (8 ¹ / ₂ ×11)	○	○	○		
5 ¹ / ₂ ×8 ¹ / ₂	○	○	○	○	

- Machine used as network delivery scanner

	100dpi	200dpi	300dpi	400dpi	600dpi
A3	○	○	○		
B4	○	○	○	○	
A4	○	○	○	○	
B5	○	○	○	○	○
A5	○	○	○	○	○
B6	○	○	○	○	○
A6	○	○	○	○	○
A7	○	○	○	○	○
11x17	○	○	○		
Legal (8 ¹ / ₂ ×14)	○	○	○	○	
8 ¹ / ₂ ×13	○	○	○	○	
Letter (8 ¹ / ₂ ×11)	○	○	○	○	
5 ¹ / ₂ ×8 ¹ / ₂	○	○	○	○	○

Setting Procedure

This section describes the steps for making scan settings.

- 1 Press the **[User Tools/Counter]** key.

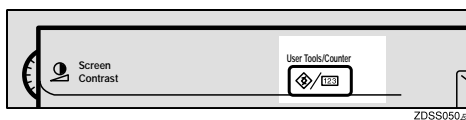

The User Tools/Counter screen appears.

- 2 Press **[Scanner Features]**.

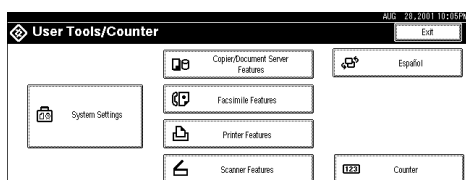

The Scanner Features screen appears.

- 3 Verify that the **[Scan Settings]** tab is shown.

- 4 Verify that **[Program/Change]** is selected, and select the scan setting item you want to program.

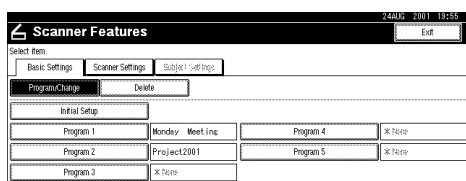

The screen for naming the set of scan settings appears.

- 5 Enter the desired name and press **[OK]**.

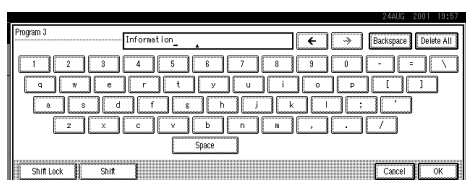

Reference

For information about character input, see the System Settings manual.

- 6 Select the item to be set.

To select an item, touch its button on the screen. The item is highlighted.

Example: resolution setting

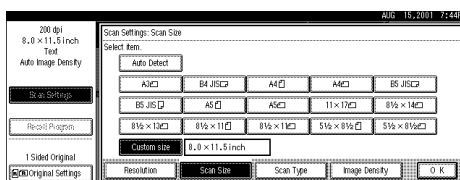

Example: image density setting

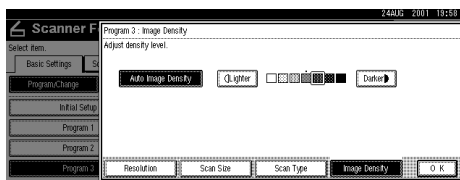

- 7 Repeat step 6 for other items.

Note

- When **[Custom Size]** is selected for **[Scan Size]**, see P.38 "Selecting a custom size".

- 8 When all settings have been made, press **[OK]**.

The scan type setting is stored.

- 9 To program other scan settings, repeat the procedure from step 4.

- 10 When all settings have been made, press **[Exit]**.

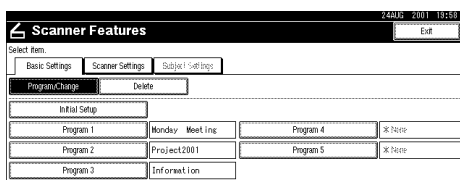

The display returns to the condition of step 2.

1 Press [Exit].

The main menu is shown again.

Selecting a custom size

When "Custom Size" is selected as the scan size, the width and height for scanning can be specified in mm from a given point.

The following describes the procedure when "Custom Size" was selected on the scan size setting screen.

4

1 Press [Custom Size] on the scan size setting screen.

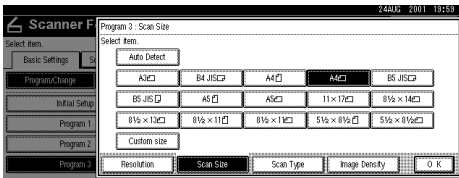

2 Enter the original size with the number keys.

Select [X1] or [Y1], enter the value, and then press [#].

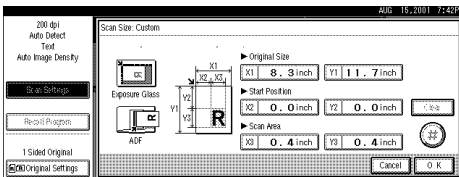

3 Use the number keys to enter the scan start point as a distance from the standard scan start point.

Select [X2] or [Y2], enter the value, and then press [#].

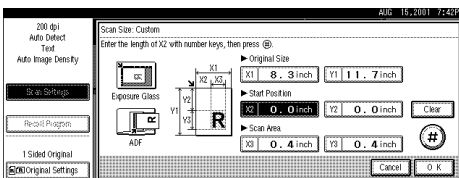

4 Enter the scan size (area) with the number keys.

Select [X3] or [Y3], enter the value, and then press [#].

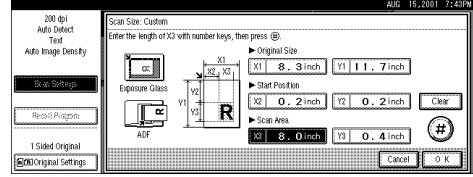

Depending on the setting condition of the original, the scan area will be as follows.

① When the original is set on the exposure glass

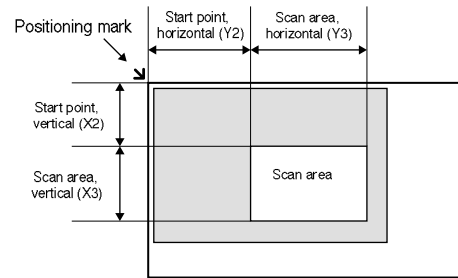

ZEKY030J

② When the original is set on the ADF

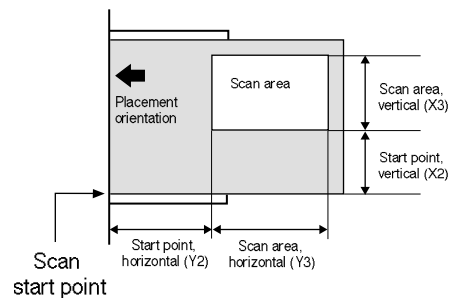

ZEKY040J

The maximum scan size is 432 mm in the Y direction (width) and 297 mm in the X direction (height). Keep the scan area settings within this range.

5 When all dimensions have been input, press [OK].

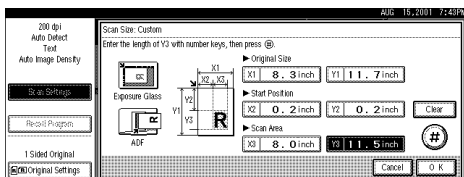

6 Verify that the area set in step 4 (X3 and Y3) is shown next to the [Custom Size] field, then press [OK].

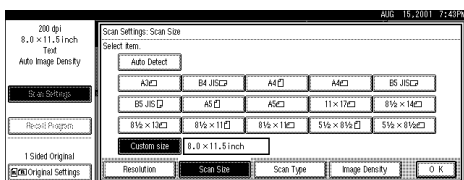

The display returns to the scanner features screen.

7 Press [Exit].

The User Tools/Counter screen is shown.

8 Press [Exit].

The main menu is shown again.

Deleting programmed scan settings

To delete programmed scan settings, proceed as follows.

1 Press the [User Tools/Counter] key.

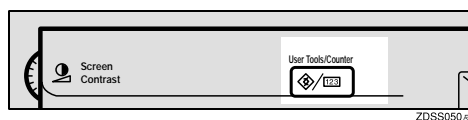

The User Tools/Counter screen appears.

2 Press [Scanner Features].

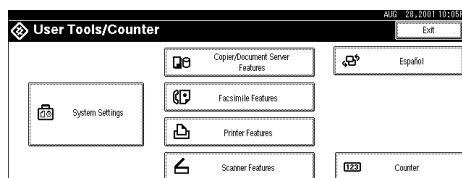

The Scanner Features screen appears.

3 Verify that the [Basic Settings] tab is shown.

4 Press [Delete].

5 Select the setting you want to delete.

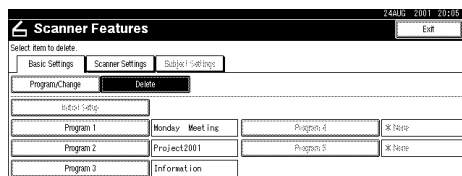

A confirmation message appears.

6 Press [Yes].

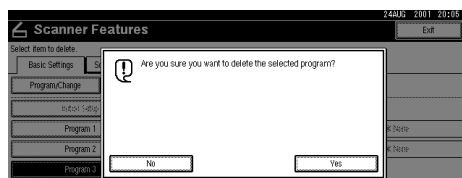

The selected set of scan settings is deleted.

7 Press [Exit].

The display returns to the condition of step 2.

8 Press [Exit].

The main menu is shown again.

Making Scanner Settings <Scanner Features: Scanner Settings >

This section explains how to make various settings for the scanner function of the machine.

Settings

The following items can be set to control the scanner functions. Make the settings as required.

Settings	Default settings	Delivery *1	TWAIN *2	Store Scan Data *3
Function Priority	Delivery/Store	<input type="radio"/>	<input type="radio"/>	<input type="radio"/>
Delivery/Store Connection Time out	10sec.	<input type="radio"/>	<input type="radio"/>	<input type="radio"/>
Compression (Black & White)	On	<input type="radio"/>	<input type="radio"/>	<input type="radio"/>
Compression (Gray Scale)	Standard	<input type="radio"/>	<input type="radio"/>	<input type="radio"/>
Delivery Option	NONE	<input type="radio"/>		
Original Setting	1-sided originals	<input type="radio"/>		<input type="radio"/>
Original Orientation Priority		<input type="radio"/>		<input type="radio"/>
Mixed Original Sizes Priority	Off	<input type="radio"/>		<input type="radio"/>
SADF Auto Reset Timer	Off	<input type="radio"/>		<input type="radio"/>

*1 These items affect operation of the machine as a network delivery scanner.

*2 These items affect operation of the machine as a network TWAIN scanner.

*3 These items affect operation of the machine as a Document Server.

◆ Function Priority

This setting determines whether the network TWAIN scanner mode or the network delivery scanner mode is initially active when the scanner function is selected by pressing the **[Scanner]** key on the operation panel.

The factory default is "Delivery/Store".

Note

- When "TWAIN" is selected, the machine will operate as a network TWAIN scanner when the **[Scanner]** key is pressed. By pressing **[Cancel]** in this condition, you can switch to network delivery scanner operation.
- When "Delivery/Store" is selected, the machine will operate as a network delivery scanner or Document Server when the **[Scanner]** key is pressed. It is not possible to switch to network TWAIN scanner operation from these modes. To use the machine as a network TWAIN scanner, access the machine from a client computer and initiate scanning.

❖ Delivery/Store Connection Time out

When using the machine as a network delivery scanner or Document Server, accessing the machine from a client computer will switch the machine to network TWAIN scanner mode. This setting determines the delay until the machine switches to network TWAIN scanner mode.

- Selecting "Immediate" causes the network TWAIN scanner mode to be activated at once.
- When you select "Yes", you can input the delay time with the number keys (3 - 30 seconds).

The factory default is "10 seconds".

❖ Compression (Black & White)

This setting determines whether image data read with the 2-value (black-and-white) setting is to be compressed. Compression reduces the data size and thereby the time required for transferring the scan data to the computer. You can select " Off " or " On ".

The factory default is " On ".

Note

- The actual time required for data transfer will vary, depending on the data size and network load.

❖ Compression (Gray Scale)

This setting determines to which extent image data read with the multi-value (gray-scale) setting is to be compressed. Higher compression reduces the data size and thereby the time required for transferring the scan data to the computer. You can select "Standard", " High ", " Low ", or " NONE ".

The factory default is "Standard".

Note

- Compression ratio decreases in the order " High ", "Standard", " Low ", " NONE ", and the time required for data transfer increases accordingly.
- The actual time required for data transfer will vary, depending on the data size and network load.

❖ Delivery Option

This applies when a delivery server running ScanRouter V2 Lite or the optional ScanRouter V2 Professional is added to the network, and the machine is used as the network delivery scanner.

When the "Delivery Option" setting is "Yes", the following items must be set.

- "Delivery IP Address" in System Settings -- File Transfer, "Delivery Retry Interval", "Delivery Retry Count"

The factory default is "No".

❖ **Original Setting**

Set the initial value for original type and orientation. When the original is always similar, selecting this as the default makes operation easier. You can select "1 Sided Original", "2 Sided Orig.: T to T" (Top to Top), or "2 Sided Orig.: T to B" (Top to Bottom).

The factory default is "1 Sided Original".

 **Reference**

For information about the binding orientation of 2-sided originals, see P.48 "Original Orientation and Scan Area Setting".

❖ **Original Orientation Priority**

Select the initial value for original placement orientation. When the original is always positioned in the same way, selecting this as the default makes operation easier. Select the appropriate orientation.

The factory default is .

 **Reference**

For information about original placement orientation, see P.48 "Original Orientation and Scan Area Setting".

❖ **Mixed Original Sizes Priority**

This setting determines whether original size is to be automatically detected when originals of different sizes are inserted in the ADF. You can select "On" or "Off".

The factory default is "Off".

 **Note**

- If the original size is specified when scanning, this setting is disregarded.
- Only originals of different paper sizes with the same leading edge length can be loaded in the ADF.

❖ **SADF Auto Reset Timer**

When all originals in the ADF have been scanned, and another original is inserted within the time interval set here, the original is read as a part of the same document.

- If "Off" is selected, the scanning of one document is terminated at the point when all originals in the ADF have been scanned.
If set to "On", enter the number of seconds (3 - 99) with the number keys.

 **Note**

- The factory default is "No". This setting item can be shown only when the ADF is installed on the machine.
The factory default is "No". This setting item can be shown only when the ADF is installed on the machine.

Setting Procedure

This section describes the steps for making Scanner Settings.

1 Press the **[User Tools/Counter]** key.

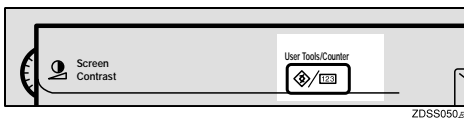

The User Tools/Counter screen appears.

2 Press **[Scanner Features]**.

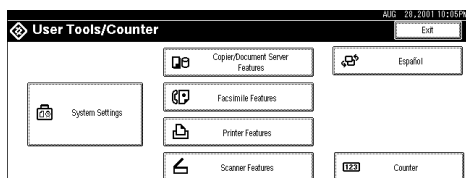

The Scanner Features screen appears.

3 Press the **[Scanner Settings]** tab.

4 Press the item to be set.

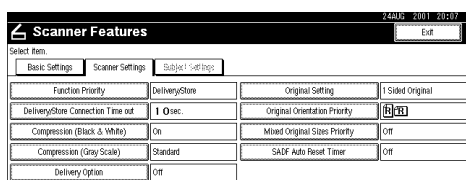

The screen for changing the item setting appears.

Example: "Compression (Gray Scale)" setting

5 Change the setting.

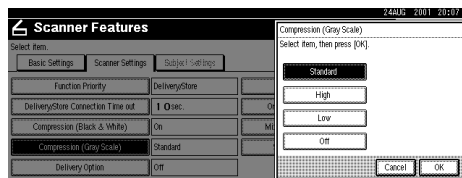

- To select an item, touch its button on the screen. The item is highlighted.
- To enter numerals, use the number keys.

Note

- For information about settings, see P.40 "Settings".
- To cancel a setting, press **[Cancel]**. The value is not changed and the display returns to the previous condition.

6 Press **[OK]**.

The display returns to the condition of step **4**.

7 Repeat steps **4** to **6** to make other settings.

8 Press **[Exit]**.

The display returns to the condition of step **2**.

9 Press **[Exit]**.

The main menu is shown again.

Making Scan Data Subject Settings

<Scanner Initial Features: Subject Settings >

With ScanRouter V2 Professional, scan data files can be delivered by e-mail. Subject information can be added to these scan data files.

The subject will be used as the title when the file is delivered by e-mail. If you often send files with similar content, storing subject names will allow you to easily select a subject at the time of delivery.

The subject can be up to 12 characters long. It is entered under the **[Subject Settings]** tab of the Scanner Initial Setup.

Note

- The subject can be set when the "Delivery Option" in the Scanner Initial Setup is set to "On".

Settings

The subject can be any string of up to 16 characters. Make the setting as required.

Setting Procedure

This section describes the steps for making subject settings.

- 1 Press the **[User Tools/Counter]** key.

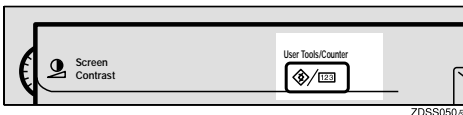

The User Tools/Counter screen appears.

- 2 Press **[Scanner Features]**.

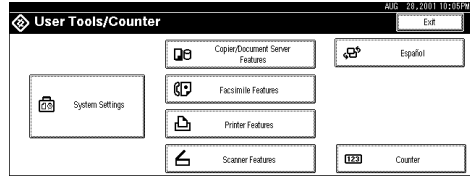

The Scanner Features screen appears.

- 3 Press the **[Subject Settings]** tab.

- 4 Verify that **[Program/Change]** is selected, and select the subject you want to program.

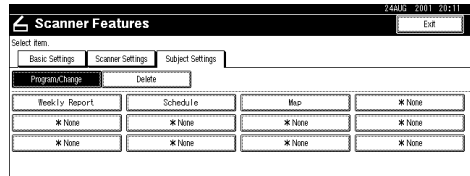

- 5 Enter the subject string.

The subject can be up to 16 characters long.

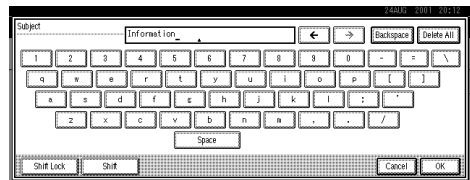

Reference

For information about how to enter characters, see the System Settings manual.

Note

- If an item is selected for which a subject is already programmed, the subject can be edited.

6 Press [OK].
The display returns to the condition of step **4**.

7 To program more subjects, repeat steps **4** to **6**.

8 Press [Exit].
The display returns to the condition of step **2**.

9 Press [Exit].
The main menu is shown again.

Deleting programmed subject settings

To delete programmed subject settings, proceed as follows.

1 Press the [User Tools/Counter] key.

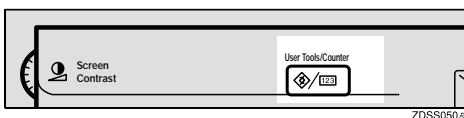

The User Tools/Counter screen appears.

2 Press [Scanner Features].

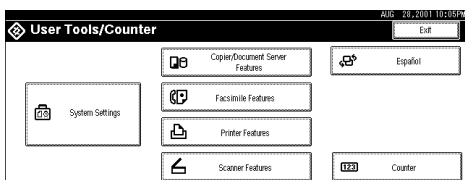

The Scanner Features screen appears.

3 Press the [Subject Settings] tab.

4 Press [Delete].

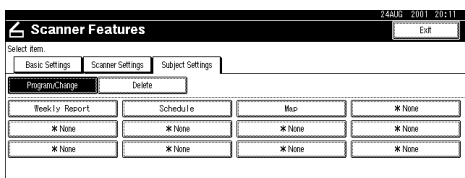

5 Select the subject you want to delete.

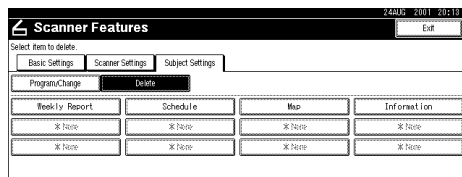

A confirmation message appears.

6 Press [Yes].

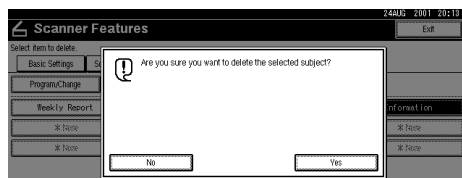

The selected subject is deleted.

7 To delete more subjects, repeat steps **5** to **6**.

8 Press [Exit].

The display returns to the condition of step **2**.

9 Press [Exit].

The main menu is shown again.

5. Scanning an Original

The network scanner function allows scanning an original and delivering the resulting scan data to another computer or storing it on the machine itself. Scanning can also be performed under control of a client computer.

This section explains the procedure for setting the original in the machine, delivering or storing the scan data, and performing other network scanner functions.

Original Setting

The original can be set either in horizontal (landscape) or vertical (portrait) orientation, but to assure that the top/bottom orientation of the original comes out correctly when the scanned file is displayed on a computer, the correct placement must be chosen.

The setting orientation differs depending on whether the width of the original is within or larger than 11.7" (A4,297 mm).

- Width is within 11.7" (A4,297 mm)

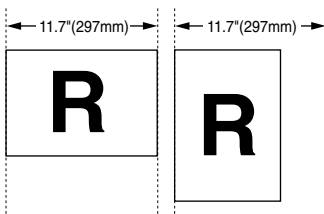

- Width exceeds 11.7" (wider than A4,297 mm)

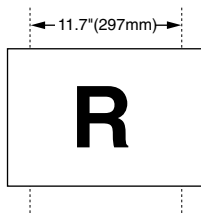

Note

- When using the machine as a network TWAIN scanner, activate the TWAIN driver on the client computer and select the original orientation. For information about making this setting, see the Network TWAIN Scanner Reference or TWAIN driver help.

Original Orientation and Scan Area Setting

When the original is set in the  orientation and both sides are to be scanned, change the original orientation setting as follows.

1 On the Scanner Function screen, press [Original Settings].

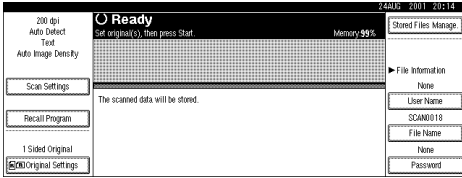

2 Make settings for original orientation, 1 sided/2 sided combination, and mixed original sizes.

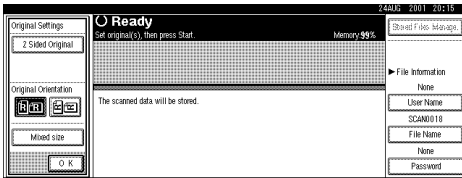

5

 **Note**

The initial values can be set under the [Scanner Settings] tab in the Scanner Initial Setup. The relevant items are " Original Setting ", " Original Orientation Priority ", and "Mixed Original Sizes Priority". => P.40 "Settings"

❖ **1-sided originals/ 2-sided original selection**

When scanning only one side, make sure that [2 Sided Original] is not highlighted.

When scanning two sides, be sure to select [T to T] or [T to B] under [2 Sided Original].

- Top to top original ([2 Sided Original] [T to T])



- Top to bottom original ([2 Sided Original] [T to B])

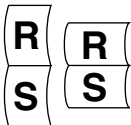

❖ **Orientation selection**

Under [Orientation], select the actual orientation of the original.

❖ Mixed sizes

When originals of different size are mixed in the ADF, the original size can be detected automatically. To enable this setting, select **[Mixed Originals]**.

Note







- To specify the original size before scanning, cancel the Mixed Originals selection.

3 Press [OK].

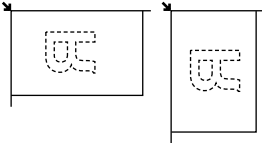
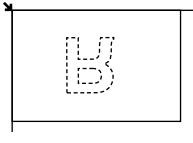
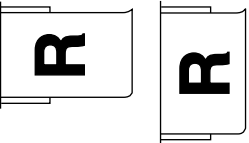
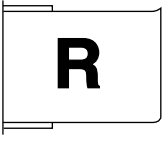
The display returns to the network delivery scanner screen.

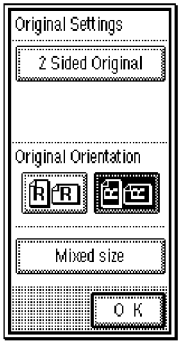

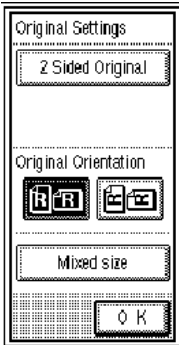





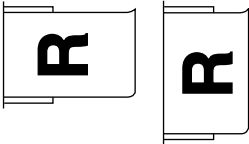

Scanning one-sided originals

The setting orientation differs depending on whether the width of original is within or larger than 11.7" (A4,297 mm).

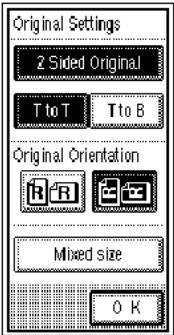
Original width	11.7" (A4,297 mm) or less	Wider than 11.7" (A4,297 mm)
When setting the original on the exposure glass ⇒ P.51 "Setting the Original on the Exposure Glass"	Place the original so that the top edge touches the top-left the exposure glass. 	Place the original so that the top edge touches the top-left the exposure glass. 
When setting the original in the automatic document feeder (ADF) ⇒ P.52 "Setting the Original in the Automatic Document Feeder (ADF)"	Place the top edge of the original first. 	Place the original so that the top edge is set into the ADF tray. 
Original orientation setting ⇒ P.48 "Original Orientation and Scan Area Setting"	Select    Note <input type="checkbox"/> Verify that [2 Sided Original] is not selected.	Select    Note <input type="checkbox"/> Verify that [2 Sided Original] is not selected.

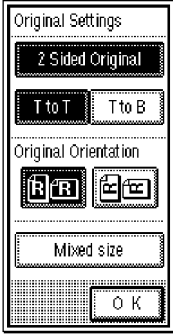
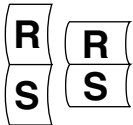
Scanning two-sided originals

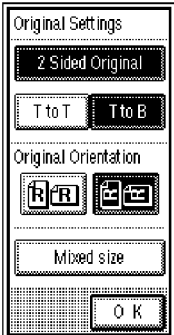
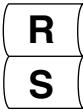
The setting orientation differs depending on whether the width of the original is within or larger than 11.7" (A4,297 mm).

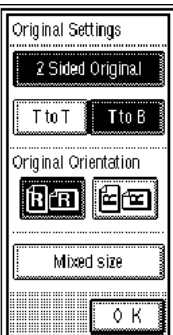
Original width	11.7" (A4,297 mm) or less	Wider than 11.7" (A4,297 mm)
<p>When setting the original on the automatic document feeder (ADF) ⇒ P.52 "Setting the Original in the Automatic Document Feeder (ADF)"</p>	<p>Place the original right side up, top edge first.</p> 	<p>Place the original right side up, in such a way that the top edge is set into the ADF tray.</p> 
<p>Original orientation setting ⇒ P.48 "Original Orientation and Scan Area Setting"</p>	<p>Top to top original</p>  <p>Select [2 Sided Original] and [T to T] .</p> 	<p>Top to top original</p>  <p>Select [2 Sided Original] and [T to T] .</p> 
	<p>Top to bottom original</p>  <p>Select [2 Sided Original] and [T to B] .</p> 	<p>Top to bottom original</p>  <p>Select [2 Sided Original] and [T to B] .</p> 

Setting the Original on the Exposure Glass

Originals which do not fit into the ADF, such as sheets with glued-on parts, books, etc. can be placed directly on the exposure glass for scanning. In this documentation, such originals are summarily called "book originals". Set such originals on the exposure glass as follows.

1 Lift the exposure glass cover or the ADF.

Note

- Raise the exposure glass cover or ADF fully (more than 30 degrees). The opening/closing action triggers the automatic original size detection process.

2 Place the original on the exposure glass with the side to be scanned facing down. Align the far left edge of the original with the mark.

For information about original orientation, see P.47 "Original Setting".

1 Original width within 11.7" (A4,297 mm)

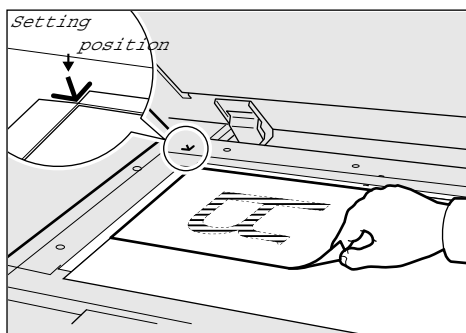

TNSY021G

When set with this orientation, the original orientation setting for delivery must be changed. ⇒ P.48 "Original Orientation and Scan Area Setting"

2 Original width exceeds 11.7" (A4,297 mm)

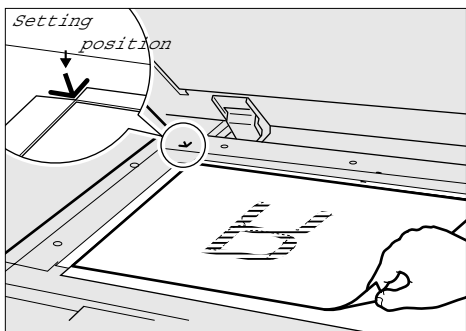

TNSY023G

Setting the Original in the Automatic Document Feeder (ADF)

The ADF allows you to set several originals at one time. The kinds of originals that can be inserted in the ADF are called "sheet originals" in this documentation. Originals set in the ADF can be scanned on one side or both sides.

The ADF also allows you to mix originals of different sizes for scanning and delivery or scanning and storage of the scan data files. In such a case, the largest original size will apply to all other originals, resulting in a white margin around the scanned area of smaller originals.

⚠ Limitation

- When using the machine as a network TWAIN scanner, original sizes should not be mixed, because correct scanning will not be carried out in such a case.

❖ Originals that can and cannot be placed in the ADF

For information about what originals can be used in the ADF, see the Copy Reference.

⚠ Important

- When using the scanner function, the following originals also may not be placed in the ADF, in addition to the restrictions that apply when using the copier function.
 - Originals longer than the height of the DLT/A3 (297mm×432mm)
- Attempting to use unsuitable originals in the ADF can lead to jamming and damage to the original. Use such originals directly on the exposure glass.

❖ Precautions when placing originals in the ADF

- Do not exceed the top mark.
- Very thin originals of 40 - 52 g/m² should be used directly on the exposure glass. Such originals may stick and be drawn in together through the ADF leading to possible damage.
- Attempting to use custom sized originals with a length greater than 11.7" (A4,297 mm) or double letter size (432 mm) in the ADF may lead to jamming.
- For information about which original sizes can be detected automatically, see the Copy Reference.

1 Align the original with the original guide.

2 Insert the originals with the side to be scanned facing up. (For originals which are to be scanned on both sides, the first side should face up.)

For information about original orientation, see P.47 "Original Setting".

Note

- It is possible to mix originals of different sizes for scanning and scan data delivery and storage. In this case, the largest original size will apply to all other originals, resulting in a white margin around the scanned area of smaller originals.
 - Originals are scanned in the inserted order, starting with the topmost page.
- 1 Original width within 11.7" (A4,297 mm)**

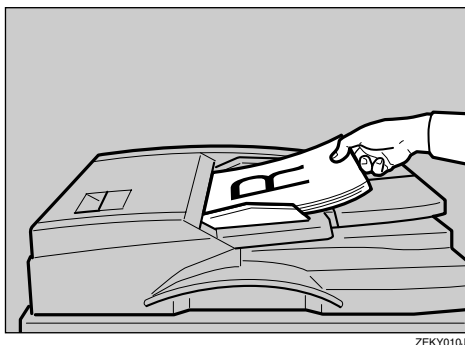

When set with this orientation, the original orientation setting for delivery must be changed. ⇒ P.48 "Original Orientation and Scan Area Setting"

- 2 Original width exceeds 11.7" (A4,297 mm)**

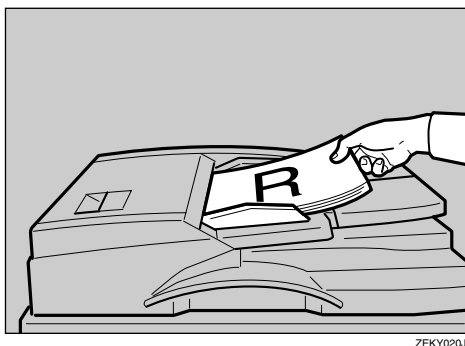
**Note**

- When scanning both sides, the original orientation setting for delivery must be changed, regardless of the orientation. ⇒ P.48 "Original Orientation and Scan Area Setting"

Using as a Network Delivery Scanner

Using the network delivery scanner function, the data obtained by scanning an original can be automatically sent to a specified destination. This section explains the various display screens and the operation steps for using this function and for verifying that delivery has been carried out correctly.

Note

- Information about delivery destinations and senders must be programmed first into the delivery server, using the ScanRouter V2 Administration Utility. For details on how to use the ScanRouter V2 Administration Utility, see the ScanRouter V2 Lite/Professional Management Guide and ScanRouter V2 Administration Utility Help.

List Display of Destinations and Senders

5

When using the machine as a network delivery scanner, a table of destinations is shown on the operation panel. This list reflects the destination and sender information programmed into the delivery server with the ScanRouter V2 Administration Utility. Pressing **[Update Address]** on the operation panel causes the machine to access the delivery server and get the latest information.

The display configuration when using the machine as network delivery scanner is as follows.

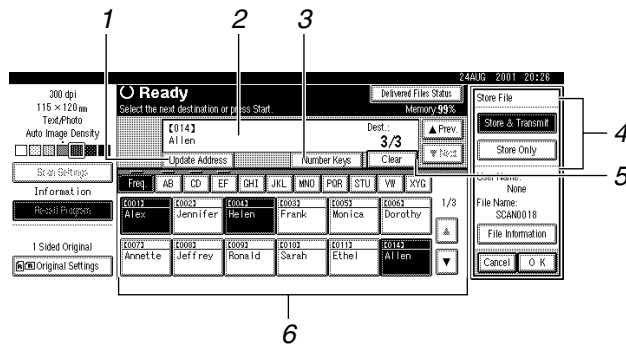

1. [Update Address]

Press this button to have the machine access the delivery server and get the latest destination and sender information.

Important

- The destination and sender information shown on the operation panel of the machine is not automatically updated when the information in the delivery server changes. Before delivering scan data, you should therefore press **[Update Address]** to display the latest information.

Note

- When the list information shown on the operation panel is updated, any current destination and sender selections will be canceled. Update the list before selecting destination and sender.

2. Destination display

The selected destination is shown here. If several destinations are selected, you can use [▲] and [▼] to move through the list.

Note

- Pressing [Check Settings] also lets you verify the selected destination(s).

3. [Number Keys]

Use these to specify a destination using the 3-digit short ID number.

4. You can change the sender name and subject for the file to be sent, or check the current settings.

5. [Clear]

Pressing this button clears a selection in the destination list or a short ID number input.

6. Destination list

This list shows destinations that can be selected. The user, group, and title information is programmed with the ScanRouter V2 Administration Utility. For details on how to use the ScanRouter V2 Administration Utility, see the ScanRouter V2 Lite Management Guide and ScanRouter V2 Administration Utility Help.

Note

- A bar above a title indicates that a destination that belongs to it has been selected.
- Group destinations are denoted by this symbol: **■■■**
- When the entire list does not fit on one screen, [▲] and [▼] can be used to scroll the display.

Delivery Procedure

To scan an original and send the scan data to a specified destination, proceed as follows.

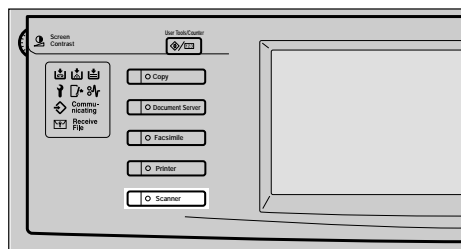
1 Press the [Scanner] key.

ZEKS020s

The scanner function screen appears.

Note

- If the network TWAIN scanner screen is displayed, press [Cancel]. This screen is displayed if "Function Priority" in the Scanner Initial Setup is set to network TWAIN scanner mode.

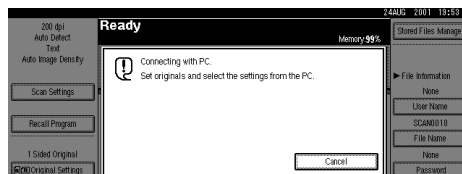
**2 Set the original in the machine, and adjust the settings for original size and orientation if required.****Reference**

For details on original size and orientation, see P.48 "Original Orientation and Scan Area Setting".

3 Set the scan settings.

Note

- If no input is made during the interval set with the "Scanner Auto Reset Timer" has elapsed, the scan settings are cleared and the initial Scanner Settings (as set with the [Scan Settings] tab under [Scanner Initial Setup] will become active.

2 Select the desired resolution and other items.

For details on how to set and program scan settings, see P.35 "Making Scanner Settings < Scanner Features : Basic Settings >".

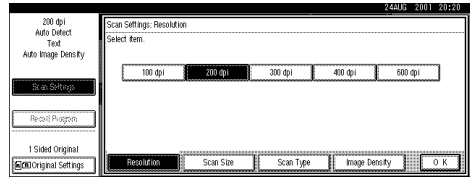

Note

- All settings made here will be cleared after the interval set with the "Scanner Auto Reset Timer" in the Scanner Initial Setup has elapsed.

3 Press [OK].

The new settings become active.

4 Select the delivery destination.

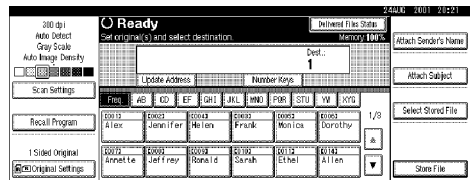

Directly selecting the destination

1 Press [Update Address] to update the list of destinations.

Important

- The destination and sender information shown on the operation panel of the machine is not automatically updated when the information in the delivery server changes. Before delivering scan data, you should therefore press [Update Address] to display the latest information.

Calling up stored scan settings

1 Press [Recall Program].

The user program recall screen appears.

2 Select a user program of scan settings.

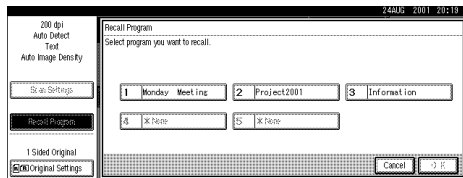

3 Press [OK].

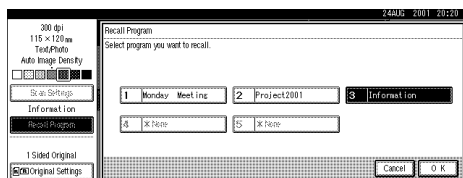

The selected user program settings become active.

Temporarily changing the scan settings

1 Press [Scan Settings].

The scan settings screen appears.

Note

When the list information shown on the operation panel is updated, any current destination and sender selections will be canceled. Update the list before selecting destination and sender.

If there is scan data in the memory of the machine that have not yet been delivered, **[Update Address]** is not available.

2 Press the title for the desired destination and select the destination.

If the desired destination is not visible, use **[▲]** and **[▼]** to scroll the display.

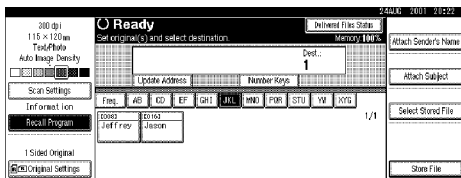
**Note**

The destination title information is programmed with the ScanRouter V2 Administration Utility. For details on how to set titles, see ScanRouter V2 Administration Utility Help.

3 Press the destination to which the scan data is to be sent.

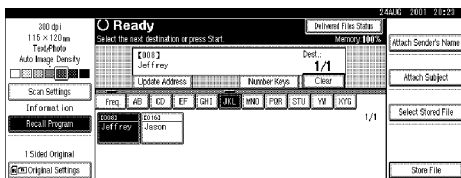

The selected destination is highlighted, and also appears in the destination field at the top of the screen. A line appears over the title of the category to which the destination belongs.

Note

To deselect a destination, press the destination once more, or use **[▲]** and **[▼]** to bring up the destination in the destination field and press **[Clear]**.

4 To select more destinations, repeat step 3.

Using the Short ID number to select a destination

1 Press [Number Keys].

2 Use the number keys to enter the 3-digit number that has been assigned to each destination.

If the entered number is less than 3 digits, terminate the entry with **[#]**.

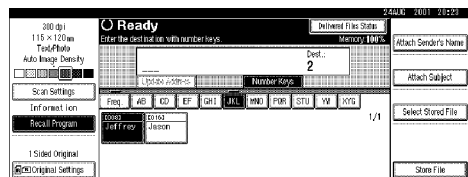

The destination corresponding to the short ID number appears in the destination field at the top of the screen.

Note

The short ID number is set with the ScanRouter V2 Administration Utility. For information about how to set the number, see ScanRouter V2 Administration Utility Help.

To deselect a destination, use **[▲]** and **[▼]** to display the destination in the destination field and press **[Clear]**.

3 To select more destinations, repeat step 2.

7 Scan the original.

- To deliver the scan data file, press the **[Start]** key.
The original is scanned, and the scan data file is delivered to the destination(s).
- When wishing to store the scan data file as well as deliver it, make the required settings for storing scan data.
For details on how to make settings for storing scan data, see P.62 "Store Procedure".

When there is another page to scan, set the original and then press the **[Start]** key. When there are no more pages, press the **[#]** key.

Note

- To abort the scanning process, press the **[Stop]** key or press **[Stop]** on the display. If the process is canceled after original pages have already been scanned, a message asking whether already scanned data is to be delivered or stored appears. Specify the desired action.
- When originals are being scanned using the ADF and the "SADF Auto Reset Timer" is enabled, loading the next original within the specified interval will cause the scan data to be treated as a single file.

Checking the Delivery Result

The delivery result can be checked for the last 50 delivery operations.

Important

- When the main power switch of the machine is turned off, all delivery result data is cleared.
- Date/Time
The date and time when the file transfer of scan data from the machine to the delivery server was completed is recorded.

Note

- If delivery retry was performed but unsuccessful, the date and time refers to the last retry operation.
 - Destination
- ### Note
- When multiple destinations were selected, the first selected destination is displayed.
 - Sender
 - File Name
 - Original
Number of scanned pages
 - Result

Indicates whether delivery was successful or resulted in an error.

1 Press **[Delivered Files Status]** on the network delivery scanner screen.

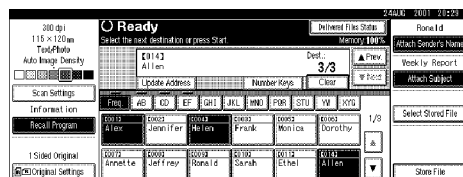

The delivery status is displayed.

2 Check the displayed results.

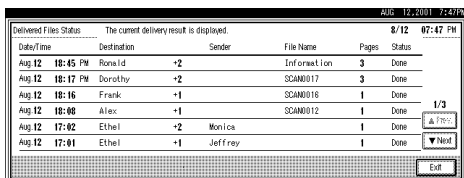

The screenshot shows a terminal window titled 'Delivered Files Status' with the subtitle 'The current delivery result is displayed.' The window displays a table with columns: Date/Time, Destination, Sender, File Name, Pages, and Status. The table contains six rows of data. At the bottom right, there is a 'Next' button and an 'Exit' button.

Date/Time	Destination	Sender	File Name	Pages	Status
Aug.12 18:45 PM	Rona Id	+2	Information	3	Done
Aug.12 18:17 PM	Dorothy	+2	SCAM0017	3	Done
Aug.12 18:16	Frank	+1	SCAM0016	1	Done
Aug.12 18:08	Alex	+1	SCAM0012	1	Done
Aug.12 17:02	Ethel	+2	Monica	1	Done
Aug.12 17:01	Ethel	+1	Jeffrey	1	Done

Note

- One screen shows the results for six delivery operations. Use [▲] and [▼] to scroll through the display.
- After five seconds, the display returns to the screen of step 1.

3 Press [Exit].

5 The display returns to the network delivery scanner screen.

Storing Scan Data in the Document Server

Data obtained by scanning originals with the network scanner function of the machine can be stored in the machine itself using the Document Server function. Stored data can be assigned a user name, file name, and password. Using DeskTopBinder V2, the files in the Document Server can be viewed, deleted, or retrieved from a client computer on the network.

This section describes how to store data in the Document Server and how to assign file information to stored data.

Note

- Stored data will be preserved also when the main power switch of the machine is turned off or when a power failure occurs.
- The theoretical maximum number of files that can be stored is 3000(or 9000 pages). However, the actual maximum may be less, depending on the space used by the copy function and other functions of the machine.
- The maximum number of pages per scan data file is 500.
- Scan documents cannot be printed from the Document Server. Retrieve the document using DeskTopBinder V2, and then print.→ DeskTopBinder V2 Help

Reference

For details about the use of DeskTopBinder V2 Lite, see the DeskTopBinder V2 Lite Introduction Guide.

◆ When using in parallel with a network delivery scanner

When a delivery server running ScanRouter V2 Lite/Professional is added to the network and the machine is used as a network delivery scanner, stored scan data files can be delivered at any time and in any combination. This can be done simply by specifying the files, without needing to scan the originals again.

The following store and delivery options can be selected.

- Deliver only
Scanned data is delivered as files but not stored in the Document Server.
- Store Only
Scanned data is stored in the Document Server but not delivered as files.
- Store & Transmit
Scanned data is delivered as files but also stored in the Document Server.

Reference

For information about how to deliver scan data files stored in the Document Server, see P.67 “*Delivering/Managing Stored Scan Data*”.

Store Procedure

Scan documents and store them in the Document Server.

- 1 Press the **[Scanner]** key.

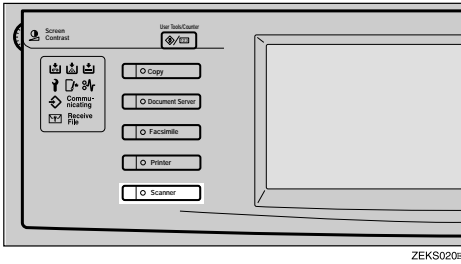

ZEKS020E

The scanner function screen appears.

Note

- If the network TWAIN scanner screen is displayed, press **[Cancel]**. This screen is displayed if "Function Priority" in the Scanner Initial Setup is set to network TWAIN scanner mode.

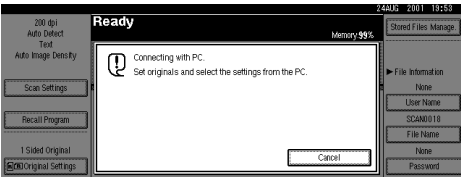

- 2 Set the original in the machine, and adjust the settings for original size and orientation if required.

Reference

For details on original size and orientation, see P.48 "Original Orientation and Scan Area Setting".

- 3 Set the scan settings.

Note

- If no scan settings are specified, the initial Scanner Settings (as set with the **[Scan Settings]** tab under **[Scanner Initial Setup]** will become active.

Calling up stored scan settings

- 1 Press **[Recall Program]**.

The user program recall screen appears.

- 2 Select a user program of scan settings.

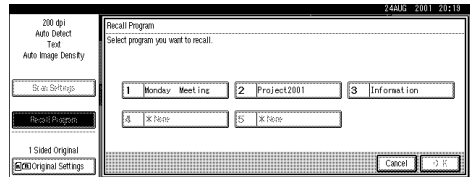

- 3 Press **[OK]**.

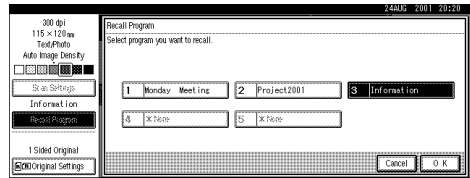

The selected user program settings become active

Temporarily changing the scan settings

- 1 Press **[Scan Settings]**.

The scan settings screen appears.

- 2 Select the desired resolution, original size, and other items.

For details on how to set and program scan settings, see P.35 "Making Scanner Settings < Scanner Features : Basic Settings >".

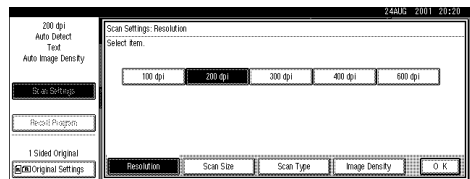

Note

- All settings made here will be cleared after the interval set with the "Scanner Auto Reset Timer" in the Scanner Initial Setup has elapsed.

4 When using the network delivery scanner function, make the settings for storing scan data files.

When not using the network delivery scanner function, this step is not required. Go to step 5.

1 Press [Store File].

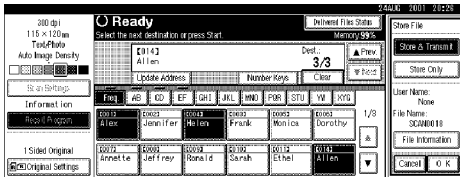

The screen for setting scan data store parameters appears.

2 Select the desired settings.

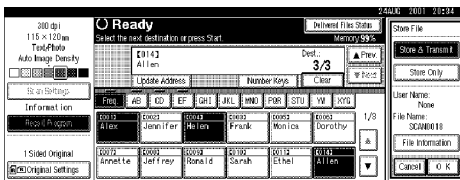

- To store and deliver scan data, press **[Store & Transmit]**.
- To only store scan data, press **[Store Only]**.

Note

- If **[Store & Transmit]** was selected, make the required delivery settings before scanning the original. For information about selecting destinations, see P.55 "Delivery Procedure".

5 Specify file information.

Specify a user name, file name, and password for the file to be stored.

Reference

For information about how to specify file information, see P.64 "Specifying file information".

6 To use the network delivery scanner function, press [OK].

The display returns to the scanner function screen.

When not using the network delivery scanner function, this step is not required. Go to step 7.

7 Press the [Start] key.

The original is scanned and the resulting data is stored as a file in the Document Server.

When there is another page to scan, set the original and then press the **[Start]** key. When there are no more pages, press the **[#]** key.

Note

- If **[Store & Transmit]** was selected in step 4, the scan data will be delivered and stored at the same time.
- To abort the scanning process, press the **[Stop]** key or press **[Stop]** on the display. If the process is canceled after original pages have already been scanned, a message appears, asking whether already scanned data is to be delivered or stored. Specify the desired action.
- When originals are being scanned using the ADF and the "SADF Auto Reset Timer" is enabled, loading the next original within the specified interval will cause the scan data to be treated as a single file.

Specifying file information

You can specify a user name, file name, and password for stored scan data files.

When this function is used, you can search for files by user name or file name, and you can prevent unauthorized persons from accessing the files.

Note

- The file name can be up to 64 characters long. The user name can be up to 20 characters long. The first 16 characters are shown on the operation panel. With DeskTopBinder V2 installed on a client computer, you can view the entire string.

- On the scanner function screen, press **[Store File]**.

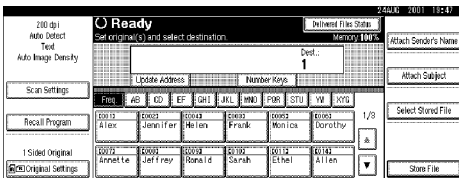

Note

- When not using the network delivery scanner function, this step is not required. Go to step 3.

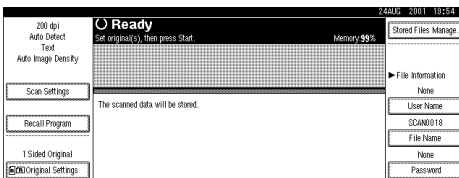

- Press **[File Information]**.

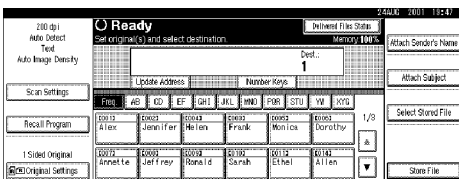

- Enter the desired information.

This screen appears when the network delivery scanner function is not used.

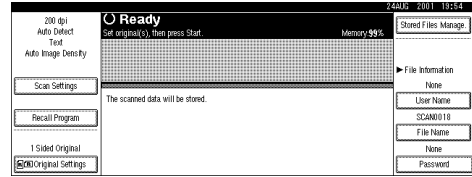

This screen appears when the network delivery scanner function is used.

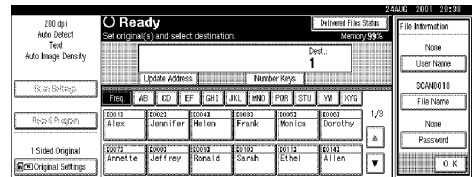

Specifying the user name

- Press **[User Name]**.

The user name selection screen appears.

- Select the user name.

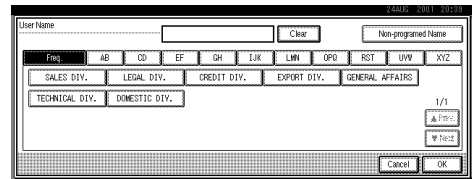

The user names shown here are names that were programmed in System Settings under the administrator tab. Select a user name and go to step 4. To enter a user name not shown here, press **[Non-programmed Name]** and go to step 3.

- 3 Enter the desired user name and press [OK].

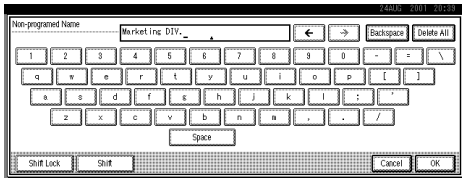

The display returns to the user name change screen.

Reference

For information about how to input characters, see the System Settings manual.

- 4 Press [OK].

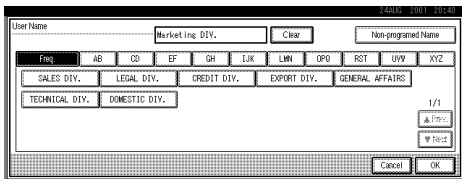

The user name is set.

Specifying a file name

Note

- ❑ Scan data files are automatically named SCAN0001, SCAN0002, etc. If desired, you can change the file name.
- ❑ You can use the same file name for different files.

- 1 Press [File Name].

The file name entry screen appears.

- 2 Enter the desired file name.

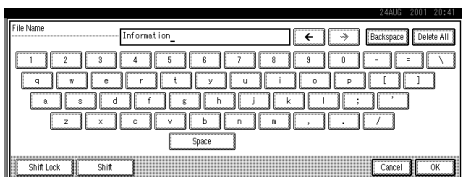

Reference

For information about how to input characters, see the System Settings manual.

- 3 Press [OK].

The new file name is set.

Specifying a password

- 1 Press [Password].

The password entry screen appears.

- 2 Enter a password consisting of four numbers.

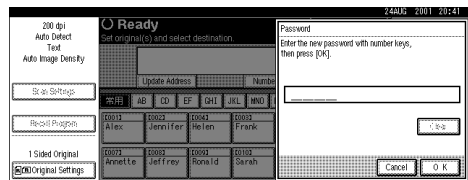

- 3 Press [OK].

The password is set.

Important

- ❑ Take care not to forget the password. If you have forgotten the password, contact the system administrator.

- 4 When using the network delivery scanner function, check the settings, and press [OK].

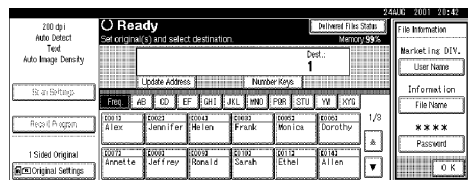

Note

- ❑ When not using the network delivery scanner function, this step is not required.

- 5 Press [OK].

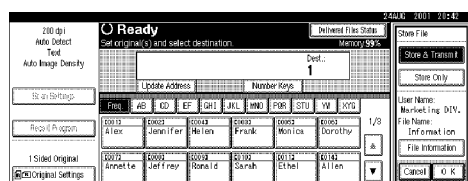

The display returns to the screen of step 1.

Using the Network TWAIN Scanner Function

If "Function Priority" in the Scanner Initial Setup is set to "TWAIN", this screen appears when the **[Scanner]** key is pressed.

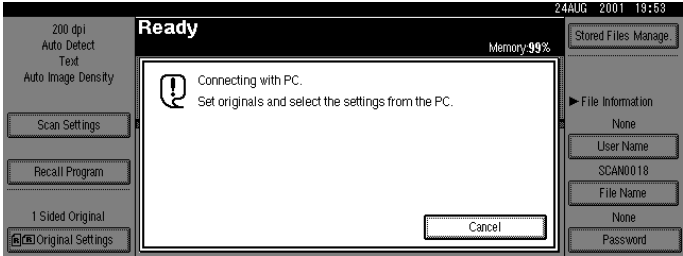

5

When using the machine as a network TWAIN scanner, the scanning process is initiated by the client computer after the original has been set in the scanner. Normally, there is no need to control the machine from the operation panel. However, the TWAIN driver has a setting for specifying that the **[Start]** key on the scanner must be pressed to start the scanning process.

For information about scanning using the TWAIN driver, see the Network TWAIN Scanner Reference. For information about loading the original, see P.47 "Original Setting".

 **Note**

- If this screen appears when you want to use the machine as a network delivery scanner or to store scan data in the Document Server, press **[Cancel]** to abort the network TWAIN scanner mode.

6. Delivering/Managing Stored Scan Data

Scan data files stored in the Document Server of the machine can be managed in various ways. You can change the user name or file name and assign passwords to prevent unauthorized access. Using DeskTopBinder V2, the files in the Document Server can be viewed, deleted, or retrieved from a client computer on the network.

When a delivery server is installed on the network and the machine is used as a network delivery scanner, you can select multiple files for bulk delivery from the machine.

! Limitation

- To deliver scan data files, a delivery server is necessary.

Viewing a List of Stored Files

From the displayed list of stored files, you can specify delivery, delete files, or view file information.

To show the displayed list of stored files, perform the following steps.

- 1** Press the **[Scanner]** key.

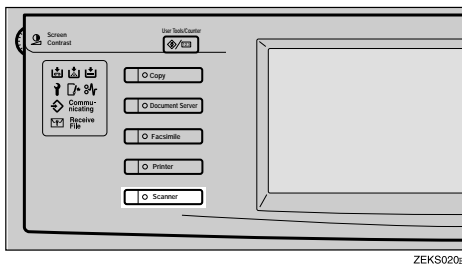

ZEKS020e

The scanner function screen appears.

Note

- If the network TWAIN scanner screen is displayed, press **[Cancel]**. If "Function Priority " in the Scanner Initial Setup is set to "TWAIN", this screen appears when the **[Scanner]** key is pressed.

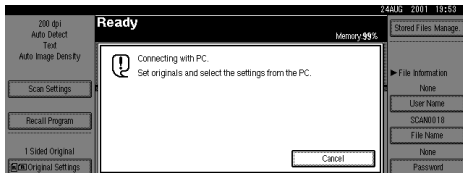

2 The list display of stored scan data files appears.

The subsequent operation steps depend on the " Delivery Option " setting in Scanner Initial Setup.

- If "Yes" is selected, press **[Select Stored File]**.

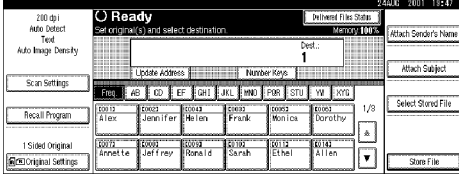

The screen for selecting a stored scan data file appears.

- If "No" is selected, press **[Stored Files Manage.]**.

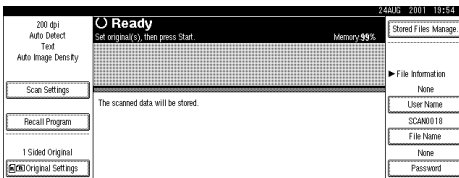

The screen for changing or deleting a stored scan data file appears.

Note

- ❑ If the " Delivery Option " is set to "No", the screen for selecting a stored scan data file does not appear.

Viewing the List

The list display of stored scan data files has the following elements.

Note

- ❑ This example assumes that the " Delivery Option " is set to "Yes".

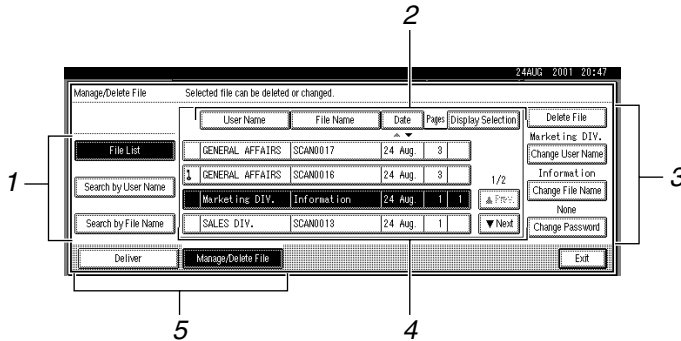

1. Switches to the screens for searching files by user name or file name, or to the screen for displaying of all files.

2. Sorts the files using the selected item as the sort key. Selecting the same item once more causes reverse sort. However, delivery cannot be sorted in descending order.

3. Use for deleting, changing the user name, file name, or password of the selected file, or for checking file information.

 **Note**

- When the " Delivery Option " in Scanner Initial Setup is set to "Yes", these items are displayed when **[Manage/Delete File]** is pressed.

4. A list of stored files is displayed.

The selected file is highlighted. Press again to cancel the selection.

 **Note**

- Stored files are not shown when a function other than the scanner function is used.
- If the desired file is not visible, use **[▲]** or **[▼]** to scroll through the display.
- For files which are password protected, a key symbol **⌘** is shown to the left of the file name.

5. Switch between the screen for specifying stored files and for changing/deleting stored files.

- **[Deliver]**
Press to display the screen for selecting a file to deliver.
- **[Manage/Delete File]**
Press to display the screen for deleting a file or changing file information.

 **Note**

- If the " Delivery Option " in Scanner Initial Setup is set to "No", these two buttons are not shown and the screen for changing/deleting a file is shown.

Searching for Files

You can search for files to be delivered, deleted, or changed, using the user name or file name as a key.

Searching by user name

You can search for a file using the user name as a key.

1 On the list display of files, press **[Search by User Name]**.

The user name search screen appears.

2 Select the user name to be used for the search.

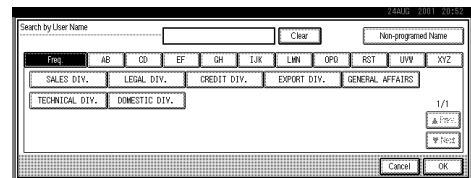

The user names shown here are names that were programmed in System Settings under the administrator tab. To enter a user name not shown here, press **[Non-programmed Name]** and enter the name.

 **Note**

- For information about how to input characters, see the System Settings manual.

3 Press **[OK]**.

The search starts, and files whose user name starts with the entered string are displayed.

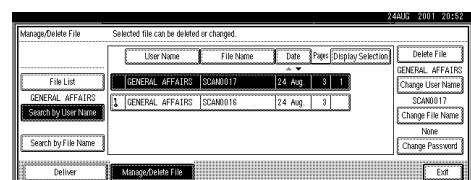

Searching by file name

- 1 At the list display of files, press [Search by File Name].

The file name search screen appears.

- 2 Enter the file name to search for.



Reference

For information about how to input characters, see the System Settings manual.

- 3 Press [OK].

The search starts, and files whose name starts with the entered string are displayed.

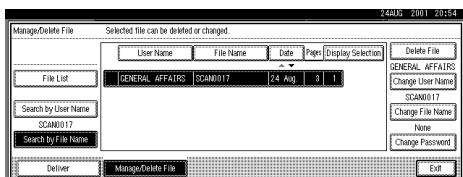

Delivering Stored Files

To deliver a scan data file stored in the Document Server, proceed as follows.

! Limitation

- To deliver scan data files, a delivery server is necessary.
- If the " Delivery Option " in Scanner Initial Setup is set to "No", delivery is not possible.

📝 Note

- This section explains mainly how to select files for delivery. For information about how to make settings for destination and delivery method, see P.55 "Delivery Procedure".

1 Display the list of stored files.

📝 Note

- For information about how to display a list of files, see P.67 "Viewing a List of Stored Files".

2 Select the file for delivery.

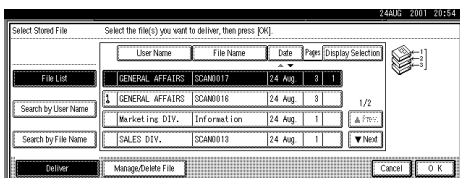

📝 Note

- When you select a password protected file, the password entry screen appears. After you have entered the correct password and pressed [OK], the file will be selected.

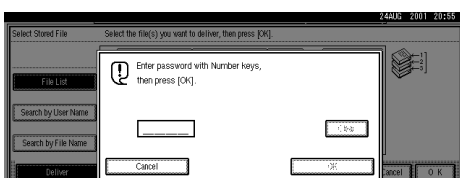

3 To select multiple files, repeat step 2.

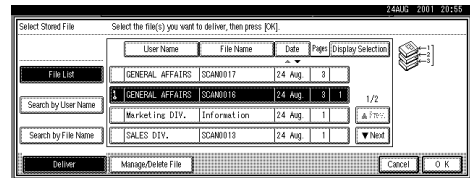

📝 Note

- You can select up to 30 files for one operation.
- If you select multiple files, the files will be delivered in the order they were selected.
- If you select [Display Selection], the selected files only will be shown in the order of delivery. Descending sort is not possible in this case.

4 Press [OK].

The file names are shown in [Select Stored File], and the machine is in standby condition for delivery.

📝 Note

- If multiple files were selected, the total number of files is also shown.

5 Specify the destination and sender information, and press the [Start] key.

The selected file(s) are delivered.

🔍 Reference

For information about checking the delivery result, see P.59 "Checking the Delivery Result".

Deleting Stored Files

You can delete files that are no longer needed.

1 Display the list of stored files.

Reference

For information about how to display a list of files, see P.67 "Viewing a List of Stored Files".

2 From the list of stored files, press [Manage/Delete File].

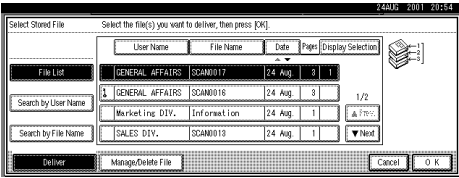

Note

- If the " Delivery Option " in Scanner Initial Setup is set to "No", this step is not required. Go to step 3.
- If the " Delivery Option " in Scanner Initial Setup is set to "Yes", up to 30 files can be deleted in one operation. Select the files before pressing [Manage/Delete File], and then go to step 4.

3 Select the file to be deleted.

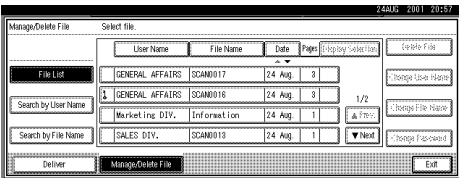

Note

- When you select a password protected file, the password entry screen appears. After you have entered the correct password and pressed [OK], the file will be selected.

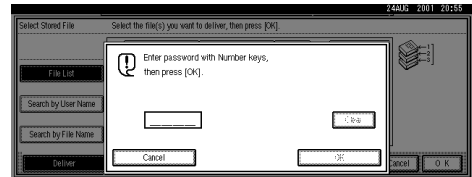

4 Press [Delete File]

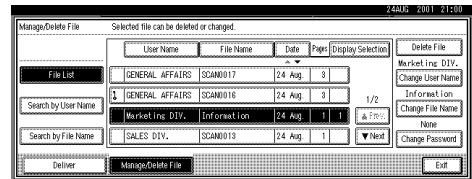

A confirmation message appears.

5 Press [Delete].

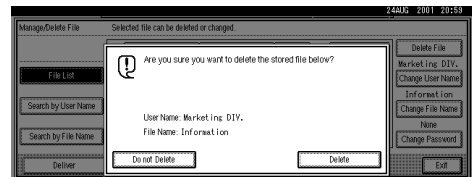

The file is deleted.

Note

- When multiple files are selected, the total number of files to be deleted is displayed.

6 Press [Exit].

The display returns to the scanner function screen.

Changing File Information

The information about files stored in the Document Server (user name, file name, password) can be changed.

Limitation

- ❑ Information for delivery standby files cannot be changed.

1 Display the list of stored files.

Reference

For information about how to display a list of files, see P.67 "Viewing a List of Stored Files".

2 Press [Manage/Delete File].

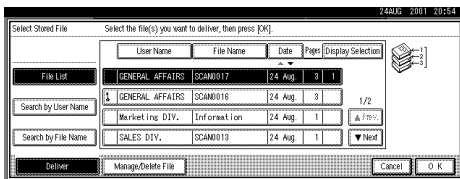

Note

- ❑ If the " Delivery Option " in Scanner Initial Setup is set to " Off ", this step is not required. Go to step 3.

3 Select the file for which you want to change the file information.

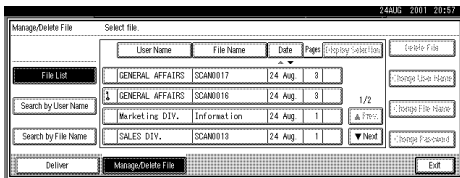

Note

- ❑ When you select a password protected file, the password entry screen appears. After you have entered the correct password and pressed [OK], the file will be selected.

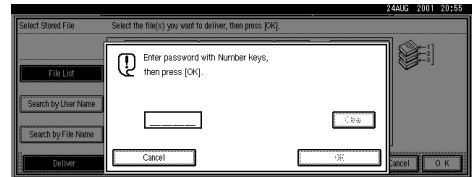

4 Change the file information.

Changing the user name

1 Press [Change User Name].

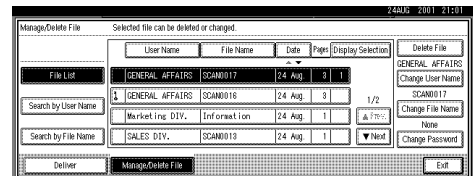

The screen for changing the user name appears.

2 Select the new user name.

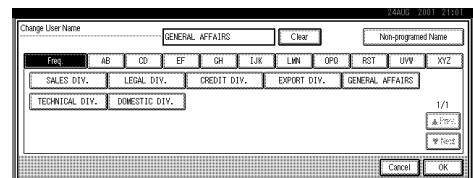

The user names shown here are names that were programmed in System Settings under the administrator tab. To use a name from the list, select it and go to step 4. To specify a user name not shown here, press [Non-programmed Name] and go to step 3.

- 3 Enter the new name and press [OK].

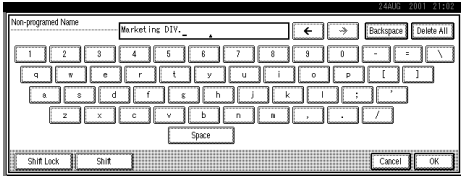

The display returns to the user name change screen.

Reference

For information about how to input characters, see the System Settings manual.

- 4 Press [OK].

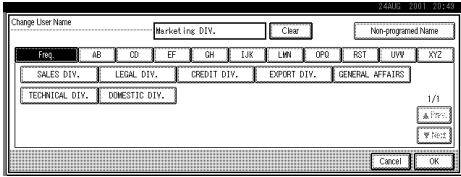

The user name is changed.

Changing the file name

- 1 Press [Change File Name].

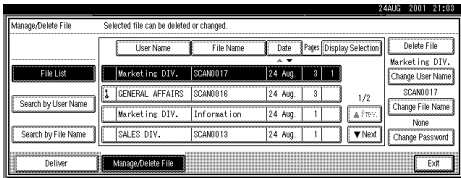

The screen for changing the file name appears.

- 2 Enter the new file name.

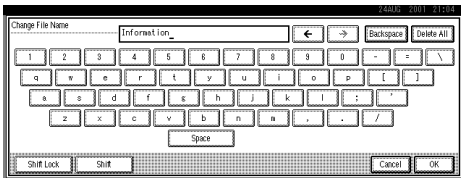

Reference

For information about how to input characters, see the System Settings manual.

- 3 Press [OK].

The file name is changed.

Assigning or changing a password

- 1 Press [Change Password].

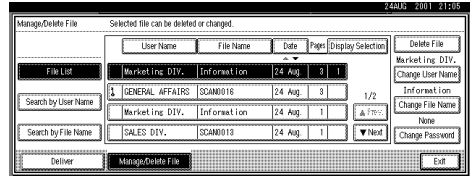

- 2 Enter the new password consisting of four numbers.

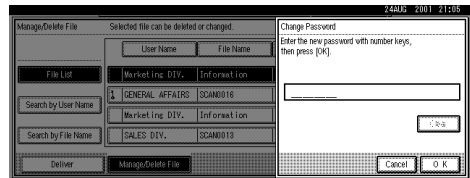

- 3 Press [OK].

The new password is stored.

Important

Do not forget the password. If you forget it, ask your system administrator.

- 5 Verify that the file information change was made as desired, and press [Exit].

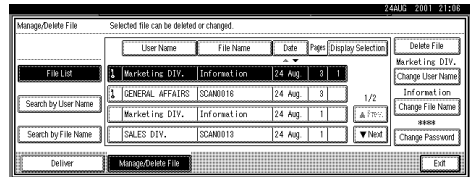

The display returns to the scanner function screen.

Troubleshooting

This section contains advice on what to do if the network delivery scanner function does not work or if you have problems scanning an original. Various messages that may appear on the operation panel are also listed, along with suitable countermeasures.

Delivery Function Does Not Work

<p>The Delivery Scanner Function screen is not displayed.</p>	<p>If the network TWAIN scanner screen appears when the machine is switched to scanner operation, press [Cancel] to switch to the network scanner screen.</p> <p>If the display does not switch from network TWAIN scanner to network delivery scanner, the network delivery Scanner Settings are not correct. see P.18 “Default Settings” and make the appropriate settings.</p>
---	--

Scanning Does Not Work Properly

<p>The scanned image contains noise.</p>	<ul style="list-style-type: none">• The exposure glass or the platen cover is dirty. Clean these parts.
<p>The image is distorted.</p>	<ul style="list-style-type: none">• The original was moved during scanning. Do not move the original during scanning.• The original was not placed flush on the exposure glass. Make sure that there is no clearance between original and the exposure glass.
<p>The image was scanned upside down.</p>	<ul style="list-style-type: none">• The original was positioned in reverse. Make sure that the top/bottom orientation is correct.
<p>The image was not scanned.</p>	<ul style="list-style-type: none">• The original was positioned upside down. Make sure that the original facing orientation is correct. When placed directly on the exposure glass, the side to be scanned must face down. When fed via the ADF, the side to be scanned must face up.

Error Message is Displayed

This section describes error messages that appear on the operation panel of the machine. Messages are divided into scan setting errors, hardware errors, and network delivery scanner errors.

 **Note**

- ❑ If an error message that is not contained in this section appears, turn off the main power switch of the machine, and then turn it on again. If the message still is shown, note the content of the message and the error number and contact your service representative.

 **Reference**



If an error message appears on the client computer from which scanning is to be controlled, see the Network TWAIN Scanner Reference .

Scan setting errors

<p>Cannot detect original size. Select scan size and reset originals.</p>	<ul style="list-style-type: none"> • Reset the original correctly. • Specify the scan size. • When placing an original directly on the exposure glass, the opening/closing action of the ADF triggers the automatic original size detection process. Raise the ADF by more than 30 degrees.
<p>Exceeded max. data capacity. Check the scanning resolution.</p>	<ul style="list-style-type: none"> • Specify the scan size and resolution again. Note that it may not be possible to scan very large originals. ⇒ P.36 “Relationship between resolution and original size”

Hardware errors

<p>Original misfeed. Scanning has been cancelled. Press [Transmit] to transmit the scanned data. To delete the data, press [Cancel].</p>	<ul style="list-style-type: none"> • There is a paper jam in the ADF. Remove the jammed original and specify whether to use the data or not.
<p>Memory is full. Cannot scan.</p>	<p>Because of insufficient memory, the first page could not be fully scanned. Try one of the following measures.</p> <ul style="list-style-type: none"> • Wait a while and retry the scan operation. • Reduce the scan area. • Delete unneeded stored files.
<p>Memory is full. Press [Transmit] to transmit the scanned data. To delete the data, press [Cancel].</p>	<ul style="list-style-type: none"> • Because there is not enough memory in the machine, the page could be scanned only partially. Specify whether to use the data or not.

<p>Memory is full. Cannot scan. Stored files delivery is only available.</p> <p> Note</p> <p><input type="checkbox"/> These messages are shown alternately.</p>	<ul style="list-style-type: none"> • There is not enough remaining memory capacity. No more files can be stored. Delete unneeded files.
<p>Memory is full. Delete the unnecessary stored files.</p> <p> Note</p> <p><input type="checkbox"/> These messages are shown alternately.</p>	<ul style="list-style-type: none"> • There is not enough remaining memory capacity. No more files can be stored. Delete unneeded files.
<p>Memory is full. Scanning has been cancelled. Do you want to store the scanned data?</p>	<ul style="list-style-type: none"> • Because there is not enough memory in the machine, the page could be scanned only partially. Specify whether to use the data or not.
<p>Exceeded max. number of pages per file. Do you want to store the scanned pages as 1 file?</p>	<ul style="list-style-type: none"> • The maximum number of pages per file is 500. Specify whether to use the data or not. Scan the page that could not be read once more as a new file.
<p>Original misfeed. Scanning has been cancelled. Do you want to store the scanned data?</p>	<ul style="list-style-type: none"> • There is a paper jam in the ADF. Remove the jammed original and specify whether to use the data or not.
<p>Exceeded max. file capacity. Delete the unnecessary stored files.</p>	<ul style="list-style-type: none"> • The maximum number of files that can be stored is 3000. Delete unneeded files.
<p>Scanner is currently in use for another function. Cannot scan.</p>	<ul style="list-style-type: none"> • The machine is currently using the scanner for another function, such as copying. Retry the operation after the other function is completed.

Network delivery scanner errors

<p>Exceeded max. number of stand-by files. Try again after the data transmission is completed.</p>	<ul style="list-style-type: none"> • There are 50 standby files in the sending queue for the delivery server. No more files can be added to the queue. Wait until files have been sent.
<p>Destination and sender list update has been failed. Try again?</p>	<ul style="list-style-type: none"> • Check whether the delivery server has started operation.
<p>Cannot use destination list because the stored destinations have been found over 200.</p>	<ul style="list-style-type: none"> • More than 200 destinations were programmed. Keep the number to 200 or less. ⇒ ScanRouter V2 Lite/Professional Management Guide ⇒ ScanRouter V2 Administration Utility help

<p>No destination is programmed for this number.</p>	<ul style="list-style-type: none"> The short ID number that can be assigned to each destination is not programmed in the delivery server. Use the ScanRouter V2 Administration Utility to assign a number to each destination. ⇒ ScanRouter V2 Lite/Professional Management Guide ⇒ ScanRouter V2 Administration Utility help
<p>No sender is programmed for this number.</p>	<ul style="list-style-type: none"> The short ID number that can be assigned to each sender is not programmed in the delivery server. Use the ScanRouter V2 Administration Utility to assign a number to each sender. ⇒ ScanRouter V2 Lite Management Guide ⇒ ScanRouter V2 Administration Utility help
<p>Cannot communicate with server. Check the server status.</p>	<p>No response from the delivery server. Possible causes are as follows:</p> <ul style="list-style-type: none"> The delivery server is not running or has not started delivery service. "Delivery server IP address" is not set correctly in System Settings. The machine may not be correctly connected to the network. Check the LED indicators of the Ethernet board.
<p>Transmission to the server has been failed. To confirm the result, see the [Delivered Files Status].</p>	<ul style="list-style-type: none"> While sending a file to the delivery server, a network error has occurred and the file could not be sent correctly. Try the operation once more. If the message still is shown, note the content of the message and the error number and contact your supplier. If multiple files were sent, use the Delivered Files Status screen to check for which file the problem occurred.
<p>Transmission has been failed. Insufficient memory in server.</p>	<ul style="list-style-type: none"> There is not enough free space on the hard disk of the delivery server. Free up the required amount. ScanRouter V2 Lite/Professional Management Guide
<p>Cannot select over 30 files at the same time.</p>	<ul style="list-style-type: none"> To select more than 30 stored files, divide the operation into several times.
<p>Transmission to the server has been failed. The data will be retransmitted later.</p>	<ul style="list-style-type: none"> A network error has occurred and a file was not sent correctly to the delivery server. Wait until retry is performed automatically after a preset interval. If the retry fails again, notify the network administrator.

File store operation errors

<p>Selected file is currently in use. Cannot delete it.</p>	<ul style="list-style-type: none"> • A file that is being edited with DeskTopBinder V2 or that is in a standby queue cannot be deleted. Try the operation again after editing is terminated or standby was canceled.
<p>Selected file is currently in use. Cannot change file name.</p>	<ul style="list-style-type: none"> • The name of a file that is being edited with DeskTopBinder V2 or that is in a standby queue cannot be changed. Try the operation again after editing is terminated or standby was canceled.
<p>Selected file is currently in use. Cannot change user name.</p>	<ul style="list-style-type: none"> • The user name of a file that is being edited with DeskTopBinder V2 or that is in a standby queue cannot be changed. Try the operation again after editing is terminated or standby was canceled.
<p>Selected file is currently in use. Cannot change password.</p>	<ul style="list-style-type: none"> • The password of a file that is being edited with DeskTopBinder V2 or that is in a standby queue cannot be changed. Try the operation again after editing is terminated or standby was canceled.
<p>The selected files contain the file deleted. Check the stored files status.</p>	<ul style="list-style-type: none"> • After selecting the files, some files were deleted with DeskTopBinder V2. Perform the selection process again.
<p>Transmission has been cancelled due to containing the deleted file. Try again after checking the stored files status.</p>	<ul style="list-style-type: none"> • Before sending the files, some files were deleted with DeskTopBinder V2. Perform the selection again and resend the files.

Instructions for Powering Off the Machine

Peripheral devices such as the HDD unit and memory are used by a variety of functions. Correct power-off procedures must be observed in order to avoid damaging these peripherals. Also, remember that powering off the machine may result in loss of any scan data that is awaiting transmission.

This section explains procedures and precautions to be observed when turning off the machine's main power.

Reference

For details, see "Turning On the Power" in the Copy Reference.

Turning Off the Power

- 1** Make sure that the platen cover and ADF are closed.
- 2** Press the operation switch and check that the power indicator goes off.

Note

- Under the following conditions, pressing the operation switch causes the power indicator to flash instead of going out.
 - The platen cover or ADF is open.
 - Communication is taking place between the machine and a connected device.
 - The HDD unit is operating.

Turning Off the Main Power

- 1** Make sure that the power indicator is off.

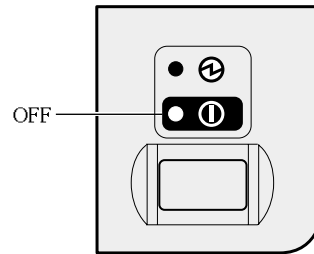

ZEF5080E

Important

- Do not turn off the main power switch if the power indicator is lit or flashing. Damage to the HDD unit or memory may result. Damage to the hard disk or memory may also result if the power switch is turned off while scanning is in progress.

- 2** Turn off the main power switch and check that the main power indicator goes off.

⚠ Important

- Before turning off the main power switch or unplugging the machine, check that the Scanner Function screen shows 100% memory remaining. If the main power switch is turned off while memory remaining is less than 100%, whatever undelivered documents are contained in memory will be lost.
- Unplug the power cord only after turning off the main power switch. Unplugging the power cord without turning off the main power switch may damage the HDD unit, memory, or other parts of the machine.
- For details on erasing documents stored in fax memory, see the Facsimile Reference<Advanced Features>.

Important

Observe the following points when setting up the machine or changing settings. For details, see the documentation and help for ScanRouter V2 Lite, DeskTopBinder V2, and the TWAIN driver.

❖ When a dial-up router is connected in a network environment

With the ScanRouter V2 Administration Utility, ScanRouter V2 Link or DeskTopBinder V2, for network devices and client computers, the settings for the delivery server to be connected must be made appropriately. In addition, the I/O settings of the ScanRouter V2 Administration Utility must be made for the network devices to be connected via the delivery server.

If the network environment changes, make the necessary changes for the delivery server with ScanRouter V2 Administration Utility. Also, set correct information of network devices with the I/O settings of ScanRouter V2 Administration Utility.

Important

- When the software is set up to connect to the delivery server via a dial-up router, the router will dial and go on-line whenever connection to the delivery server is initiated. Telephone charges may be incurred.

❖ When connected to a computer that uses dial-up access

- Do not install ScanRouter V2 Lite/Professional on a computer which uses dial-up access.
- When using the ScanRouter V2 Administration Utility (ScanRouter V2 Lite/Professional), DeskTopBinder V2, ScanRouter V2 Link, or the TWAIN driver on a computer with dial-up access, dial-up may be performed when connecting to the delivery server and other equipment. If the computer is set up to connect to the Internet automatically, the confirmation dialog box will not appear, and telephone charges may be incurred without the user being aware of it. To prevent unnecessary dial-up, the computer should be set up so that the confirmation dialog box is always displayed before establishing a connection. Make sure that no unnecessary dial-up is performed when using the above listed software.

❖ When working in a WAN environment

In a WAN environment, do not use the ScanRouter V2 Link or other ScanRouter V2 Administration Utility installed on a client computer. In some network environments, time-out may occur and normal delivery may not be possible.

Specifications

Scan method	Flat bed scanning
Image sensor type	CCD
Scan Type	Sheet, book
Interface	Ethernet interface (10BASE-T or 100BASE-TX)
Maximum scan size	A3/DLT (297mm×432mm)
Scan density	<p>600dpi</p> <p>❖ When placed on the exposure glass</p> <ul style="list-style-type: none"> • When used as network TWAIN scanner Setting range 100 dpi - 2400 dpi(3-dpi steps) • When used as network delivery scanner Setting range 100 dpi, 200 dpi, 300 dpi, 400 dpi, 600 dpi <p>❖ When placed in the ADF</p> <ul style="list-style-type: none"> • When used as network TWAIN scanner Setting range 100 dpi - 1200 dpi(3-dpi steps) • When used as network delivery scanner Setting range 100 dpi, 200 dpi, 300 dpi, 400 dpi, 600 dpi

INDEX

C

- Checking the delivery result, 59
- [Check Settings]** key, 11
- [Clear/Stop]** key, 12
- Common key operations, 13
- Compression (Black & White), 41
- Compression (Gray Scale), 41
- Connecting to the Network, 10

D

- Default Settings, 18
- Delivery Option, 41
- Delivery/Store Connection Time out, 41
- DeskTopBinder V2, 7
- DeskTopBinder V2 Lite, 25
- Display, 11

E

- [#]** (Enter) key, 12

F

- Function keys, 11
- Function Priority, 40

I

- Image Density, 36

L

- List Display
 - Destination*, 54
 - Stored*, 68

M

- Main power indicator, 11
- Making scan settings, 37

N

- Network Delivery Scanner, 1
- Network Printing Guide Operating Instructions, i
- Network TWAIN Scanner, 3
- Number keys, 11

O

- Operation Switch, 11
- Original orientation and scan area setting, 48
 - Scanning one side of original*, 49
 - Scanning two sides of original*, 50

P

- Preparations
 - Network delivery scanner*, 15
 - Using as Network TWAIN scanner*, 16
 - Store Scan Data*, 17
- Printer Reference 1, i
- Printer Reference 2, i

R

- Relationship between resolution and original size, 36
- [Reset]** key, 11
- Resolution, 35

S

- SADF Auto Reset Timer, 42
- Scan Data Delivery, 54
- Scanner Initial Setup
 - Scanner Settings*, 40
 - Scan settings*, 35
 - Subject Settings*, 44
- ScanRouter Link V2, 8
- ScanRouter V2 Administration Utility, 7
- ScanRouter V2 Lite, 23
- ScanRouter V2 Lite/Professional, 6
- ScanRouter V2 Lite/Professional and DeskTopBinder V2, 6
- Scan Size, 35
- Scan Type, 35
- Screen configuration
 - Network delivery scanner*, 12
 - Network TWAIN scanner*, 13
 - Store Scan Data*, 13
- Selecting a custom size, 38
- Settings
 - Clock timer settings*, 31
 - File transfer settings*, 34
 - Interface settings*, 32
 - Scanner Settings*, 40
 - Scan Settings*, 35
 - Subject Settings*, 44

Setting Original on Automatic Document Feeder (ADF), 52
Setting Original on the Exposure Glass, 51
Software, 6
Software Installation, 27
Software on CD-ROM, 22
[Start] key, 12
Status indicators, 11
Stored file
 Deleting, 72
 Changing file information, 73
 Deliver, 71
 Search, 69
Store Scan Data, 4
Storing Scan Data, 61

T

TWAIN Driver Ver.3, 8, 22

U

[User Tools/Counter] key, 11

W

[Warmup] key, 11

Note to users in the United States of America

Notice:

This equipment has been tested and found to comply with the limits for a Class B digital device, pursuant to Part 15 of the FCC Rules. These limits are designed to provide reasonable protection against harmful interference in a residential installation. This equipment generates, uses and can radiate radio frequency energy and, if not installed and used in accordance with the instructions, may cause harmful interference to radio communications.

However, there is no guarantee that interference will not occur in a particular installation. If this equipment does cause harmful interference to radio or television reception, which can be determined by turning the equipment off and on, the user is encouraged to try to correct the interference by one more of the following measures:

Reorient or relocate the receiving antenna.

Increase the separation between the equipment and receiver.

Connect the equipment into an outlet on a circuit different from that to which the receiver is connected.

Consult the dealer or an experienced radio/TV technician for help.

Warning

Changes or modifications not expressly approved by the party responsible for compliance could void the user's authority to operate the equipment.

Caution (in case of 100BASE-TX environment):

Network interface cable with ferrite core must be used for RF interference suppression.

Note to users in Canada

Note:

This Class B digital apparatus complies with Canadian ICES-003.

Remarque concernant les utilisateurs au Canada

Avertissement:

Cet appareil numérique de la classe B est conforme à la norme NMB-003 du Canada.



Printer/Scanner Unit Type 1045 Operating Instructions

